



REFRIGERATOR

TRUE BUILT IN REFRIGERATOR

BASIC MODEL : RS757LHQESR/**

MODEL NAME : RS27FDBTNSR/AA

RS27FDBTNSR/AC

SERVICE Manual

REFRIGERATOR



RS27FDBTNSR/**

CONTENTS

1. PRECAUTIONS (SAFETY WARNINGS).....4
2. PRODUCT SPECIFICATIONS.....8
3. FULL DISASSEMBLY AND ASSEMBLY ...15
4. FUNCTION FOR FAILURE DIAGNOSIS....31
5. DISASSEMBLY AND REASSEMBLY49
6. PCB DIAGRAM.....64
7. WIRING DIAGRAM.....69
8. BLOCK DIAGRAM.....70
9. REFERENCE INFORMATION.....71

For the latest parts information, Please access to our service web site
(• North America : <http://gspn3.samsungcsportal.com>)



WARNING

IMPORTANT SAFETY NOTICE

The service guide is for service men with adequate backgrounds of electrical, electronic, and mechanical experience.

Any attempt to repair a major appliance may result in personal injury and property damage.

The manufacturer or dealer cannot be responsible for the interpretation of this information.

SAMSUNG ELECTRONICS AMERICA, INC.

Technical Service Guide

Copyright ©2013

All rights reserved. This service guide may not be reproduced in whole or in part in any form without written permission from the SAMSUNG ELECTRONICS Company.

Contents

1. Precautions (safety warnings)	4
2. Product specifications	8
2-1) Product Specifications.....	9
2-2) Dimensions of Refrigerator (Inches).....	12
2-3) Refrigeration Cycle	13
2-3-1. Cold Air Circulation	14
3. full Disassembly and assembly	15
3-1) PRECAUTION	16
3-2) How to Disassemble Each Component for A/S	17
3-3) Dispenser Cover	18
3-4) Handle & Cover Comp & Freezer Door.....	20
3-5) Interior Overview.....	21
3-6) Bin & Shelf & Drawer	22
3-7) Ice Maker & Evap.....	23
3-8) Duct & Rail	26
3-9) Unit & Pcb Box	28
3-10) Motor Damper.....	29
3-11) Heater & Water Valve.....	30
4. function for failure diagnosis	31
4-1) Test mode (manual operation / manual defrost function)	32
4-2) Display function of Communication error	33
4-3) Self Diagnostics function.....	33
4-4) Load Status Check function	36
4-5) Wi-fi(Network) Module Check Function.....	38
4-6) How to Access the AP Mode and register your Smart Home Product.....	39
4-7) MAC Address Display Mode	39
4-8) Refrigerator Option (Service Mode) function	40
4-9) Option TABLE.....	42
4-10) Diagnostic method according to the trouble symptom (Flow Chart).....	47
5. disassembly and reassembly	49
5-1) CCase Output Terminal	49
5-2) How to Enter the Test Mode	51
6. PCB Diagram	64
6-1) PBA Layout with part position.....	65
6-2) Connector Layout & Descriptions of Inverter Controller Board	66
6-3) Connector Layout with part position (Main Board)	67
6-4) Connector Layout with part position (Inverter PBA, SMPS PBA)	68

Contents

7. Wiring Diagram.....	69
8. Block Diagram	70
8-1) Whole block diagram.....	70
9. REFERENCE INFORMATION	71
9-1) Trouble Shooting	71
9-2) Q&A.....	73

1. PRECAUTIONS (SAFETY WARNINGS)

- Unplug the appliance before replacing or repairing electrical parts.
 - Be careful to avoid electric shock.

- When exchanging the parts, use the correct parts.
 - Check the model name, rating voltage, rating current, running temperature symbols.

- When troubleshooting, connect firmly the types of harness.
 - Make not to be separated when some power is imposed.

- Check the traces of water infiltration at the electric parts.
 - If there is a trace of water infiltration, exchange or tape the parts.

- Check the assemble status of parts after troubleshooting.
 - It must be in the same assembled state when compared with the state before disassembly.

- Check the use circumstance of refrigerator.
 - If the refrigerator is installed at the place that is damp or wet, or status of installation is unstable, change the installation place.

- Ground the refrigerator properly
 - Particularly, Be sure to earth when there is a risk of an electric leakage by humidity or wetness.

- Do not use multi plugs in a plug socket at the same time.
 - Check if the power cord and socket is damaged, pressed, squeezed, or fired.
 - If the plug or plug socket is damaged, repair or exchange it immediately.

- Do not allow consumers to repair the appliance by themselves.

- Do not store other materials except the foods.
 - Drugs or scientific materials : difficult to keep precise temperature.
 - The inflammables(alcohol, benzene, ether, LP gas, butane gas etc.): have risk of explosion.

PRECAUTIONS (SAFETY WARNINGS)

Read all instructions before repairing the product and keep to the instructions in order to prevent danger or property damage.

CAUTION/WARNING SYMBOLS DISPLAYED



Warning

Indicates that a danger of death or serious injury exists.



Caution

Indicates that a risk of personal injury or material damage exists.

SYMBOLS



means "Prohibition".



means "Do not disassemble".



means "No contact".



means "The things to be followed".



means "Power cord should be unplugged from the consent".



means "Earth to prevent Electric shock".



Warning & Caution

Unplug the appliance before servicing or replacing electrical parts.
 • It may cause electric shock.



Unplug

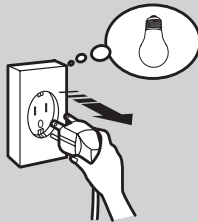

Use the rated components on the replacement.
 • Check the correct model, rated voltage, rated current, operating temperature and so on.



Rated components



On repair, make sure that the wires such as harness are bundled tightly.
 • Bundle tightly wires in order not to be detached by the external force and then not to be wetted.



On repair, remove completely dust or other things of housing parts, harness parts, and check parts.
 • Cleaning may prevent the possible fire by tracking or short.

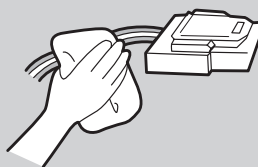

After repair, check the assembled state of components.
 • It must be in the same assembled state when compared with the state before disassembly.

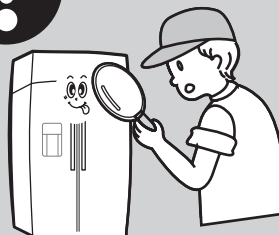

Check if there is any trace indicating the permeation of water.
 • If there is that kind of trace, change the related components or do the necessary treatment such as taping using the insulating tape

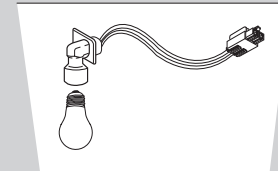

PRECAUTIONS (SAFETY WARNINGS)

* Please let users know following warnings & cautions in detail.



Warning & Caution

Do not allow users to put bottles or kinds of glass in the freezer.

- Freezing of the contents may inflict a wound.

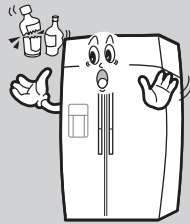

Do not allow users to store narrow and lengthy bottles or foods in a small multipurpose room.

- It may hurt you when refrigerator door is opened and closed resulting in falling stuff down.



Do not allow users to store pharmaceutical products, scientific materials, etc., in the refrigerator.

- The products which temperature control should not be stored in the refrigerator.



Do not allow users to insert the power plugs for many products at the same time.

- May cause abnormal generation of heat or fire.



Prohibited

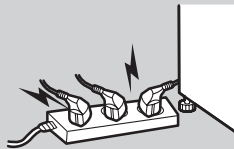

Do not allow users to disassemble, repair or alter.

- It may cause fire or abnormal operation which leads to injury.



Do not disassemble

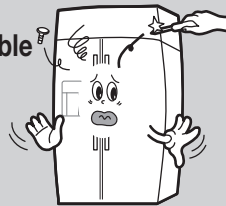

Do not allow users to bend the power cord with excessive force or do not have the power cord pressed by heavy article.

- May cause fire.

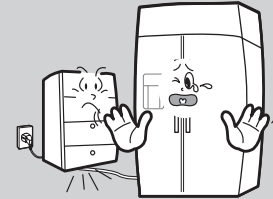

Do not allow users to store articles on the product.

- Opening or closing the door may cause things to fall down, with may inflict a wound.



Prohibited

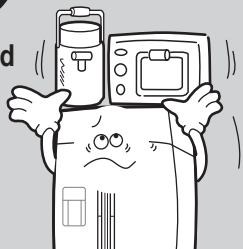

Do not allow users to install the refrigerator in the wet place or the place which water splashes.

- Deterioration of insulation of electric parts may cause electric shock or fire.

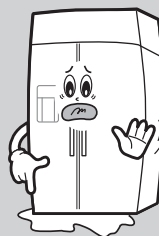

Make sure of the earth.

- If earthing is not done, it will cause breakdown and electric shock.



Earth

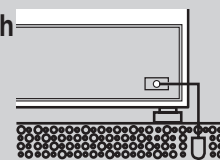

PRECAUTIONS (SAFETY WARNINGS)

FLOORING

For proper installation, this refrigerator must be placed on a level surface of hard material that is the same height as the rest of the flooring. This surface should be strong enough to support a fully loaded refrigerator, or approximately 573lb(260kg).

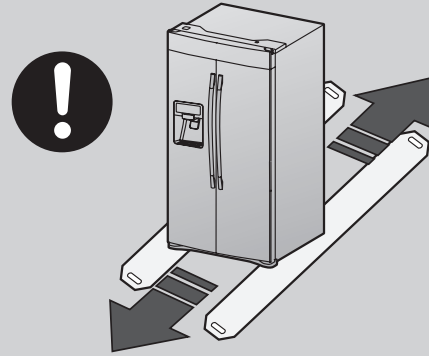

MOVING

Protect the finish of the flooring. Cut a large section of the cardboard carton and place under the refrigerator where you are working. When moving, be sure to pull the unit straight out and push back in straight.

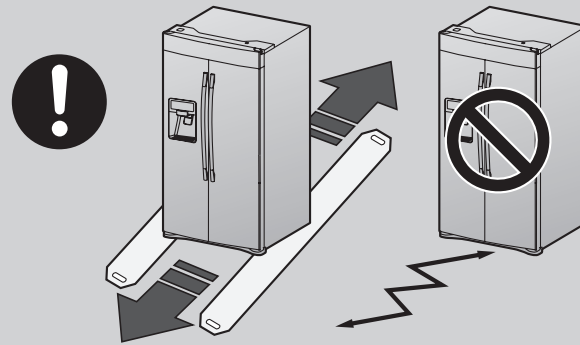



2. PRODUCT SPECIFICATIONS

2-1) Product Specifications.....	9
2-2) Dimensions of Refrigerator (Inches).....	12
2-3) Refrigeration Cycle	13
2-3-1. Cold Air Circulation	14

PRODUCT SPECIFICATIONS

2-1) Product Specifications

Model Name		BASIC	NEW	Remark
		RS27FDBTNSR/AA	DYF42SBIWS	
Product Image				
GROSS volume	Total	27.5 cu.ft (779 ℓ)	24.3 cu.ft (688 ℓ)	
	Freezer Room	10.7 cu.ft (303 ℓ)	9.2 cu.ft (261 ℓ)	
	Fridge Room	16.8 cu.ft (476 ℓ)	15.1 cu.ft (427 ℓ)	
Dimension	Width	48 inch (1217 mm)	42 inch (1067 mm)	
	Height	83.2 inch (2113 mm)	83.5 inch (2121 mm)	
	Depth	25.8 inch (655 mm)	25.8 inch (655 mm)	Without Handle
Weight (Net)		612.9 lb (278 kg)	573 lb (260 kg)	
Rated (V/Hz)		AC 115V / 60Hz	AC 115V / 60Hz	
Motor Power Consumption		162W	162W	
Heater Power Consumption		657W	657W	
Refrigerator Type		Indirect Cooling	Indirect Cooling	
Refrigerant		R134a	R134a	
Refrigerant Quantity		230g	230g	
Freezer Performance		4STAR	4STAR	

PRODUCT SPECIFICATIONS

Model Name			BASIC	NEW	
			RS27FDBTNSR/AA	DYF42SBIWS	
Cooling Components	Compressor	Model Name	MKV190CL2B/E01	MKV190CL2B/E01	
		Starting Type	INVERTER	INVERTER	
		Oil Charge	FREOL α-15(ESTER)	FREOL α-15(ESTER)	
	Evaporator	Refrigerator	FIN CROSS TYPE	FIN CROSS TYPE	
		Freezer	SPLIT FIN TYPE	SPLIT FIN TYPE	
	STEP MOTOR VALVE		DC14V Unipolar 1-2 Phase Excitation Method	DC14V Unipolar 1-2 Phase Excitation Method	
	Condenser		Forced or Natural Convection	Forced or Natural Convection	
	Dryer		MOLECULAR SIEVE XH-9	MOLECULAR SIEVE XH-9	
	Capillary Tube	Freezer	ID0.85 X L3300 4.4 Kg/cm ²	ID0.85 X L3300 4.4 Kg/cm ²	
		Refrigerator	ID0.85 X L3000 4.2 Kg/cm ²	ID0.85 X L3000 4.2 Kg/cm ²	
		Refrigerator → Freezer	ID3.36 X L1000	ID3.36 X L1000	
	Refrigerant		R-134a	R-134a	
	Freezer	THERMISTOR (F-SENSOR) PX-41C	MAX	5~-8°F (Default: 0°F)	5~-8°F (Default: 0°F)
			MID		
			MIN		
Refrigerator	THERMISTOR (F-SENSOR) PX41C	MAX	34°F	34°F	
		MID	37°F	37°F	
		MIN	44°F	44°F	
Initial Defrost Cycle (F+R Defrost)		6 Hr ±10 Min	6 Hr ±10 Min		
F-Defrost Cycle		12~48Hr (Vary according to the using conditions)	16~48Hr (Vary according to the using conditions)		
R-Defrost Cycle		6~24Hr (Vary according to the using conditions)	8~24Hr (Vary according to the using conditions)		
Idling Time		10 ± 2 Min	10 ± 2 Min		
F-Defrost Sensor	Model Name	THERMISTOR (PX-41C)	THERMISTOR (PX-41C)		
	SPEC	5.0KΩ at 25°C	5.0KΩ at 25°C		
R-Defrost Sensor	Model Name	THERMISTOR (PX-41C)	THERMISTOR (PX-41C)		
	SPEC	5.0KΩ at 25°C	5.0KΩ at 25°C		
Bimetal	Rated	AC 125V, 6A / 250V, 3A Alt) AC 125V, 10A / 250V, 5A	AC 125V, 6A / 250V, 3A Alt) AC 125V, 10A / 250V, 5A		
	On/Off	ON / OFF	ON / OFF		
	Operating Temp	40±5°C ON, 60±5°C OFF	40±5°C ON, 60±5°C OFF		
Defrost Related Components					

PRODUCT SPECIFICATIONS

Model Name		BASIC	NEW
		RS27FDBTNSR/AA	DYF42SBIWS
F- Defrost Heater	On upon F-Defrost	AC 115V 300W (SHEATH HEATER)	AC 115V, 300W (SHEATH HEATER)
F- Drain Heater		AC 120V 35W (CORD HEATER)	AC 120V, 35W (CORD HEATER)
F- SUB Drain Heater		AC 115V 10W (COLD HEATER)	AC 115V, 10W (COLD HEATER)
R- Defrost Heater	On upon R-Defrost	AC 115V, 110W (HEATER PIPE)	AC 115V, 110W (HEATER PIPE)
R -Drain Heater		AC 115V, 30W (CORD HEATER)	AC 115V, 30W (CORD HEATER)
HOME BAR Heater		-	-
Water Supply Heater		-	-
Dispenser Heater		AC 120V, 8W (CORD HEATER)	AC 120V, 8W (CORD HEATER)
Ice Maker Heater		AC120V, 145W (SHEATH HEATER)	AC120V, 145W (SHEATH HEATER)
F-Defrost Heater Overheat Protection Bimetal		AC 125V, 6A / 250V, 3A	AC 125V, 6A / 250V, 3A
R-Defrost Heater Overheat Protection Bimetal		Alt) AC 125V, 10A / 250V, 5A	Alt) AC 125V, 10A / 250V, 5A
NOISE FILTER		AC 250V 10A, 50/60 HZ	AC 250V 10A, 50/60 HZ
Overload Protector	Model Name	4TM445PHBYY-82	4TM445PHBYY-82
	On Temp	61 ± 9°C	61 ± 9°C
	Off Temp	135 ± 5°C	135 ± 5°C
MAIN FUSE		AC 250V 10A(SB)	AC 250V 10A(SB)
F-Room Cooling Fan Motor		DC12V DREP3030LC / φ67, L237.4, BLOWER FAN	DC12V DREP3030LC / φ67, L237.4, BLOWER FAN
R-Room Cooling Fan Motor		DC12V DREP3030LB / φ67, L295.5, BLOWER FAN	DC12V DREP3030LB / φ67, L295.5, BLOWER FAN
Comp Cooling Fan Motor		DC12V DRCP5030LA / φ170, SHROUD FAN	DC12V DRCP5030LA / φ170, SHROUD FAN
Fresh Island Fan Motor		-	-
Fresh Island DAMPER		-	-
ICE MAKER		AC MOTOR 115V/60 Hz, AL TRAY	DC MOTOR 12V, AL TRAY
Freezer Lamp	Top	-	LED Lamp DC 12V (6 CHIPS * 1EA)
	Rear	LED Lamp DC 12V (6 CHIPS * 4EA)	-
	Side	-	LED Lamp DC 12V (18 CHIPS * 1EA)
Fridge Lamp	Top	LED Lamp DC 12V (9 CHIPS * 1EA)	LED Lamp DC 12V (5 CHIPS * 1EA)
	Rear	LED LAMP DC 12V (6 CHIPS * 4EA)	-
	Side	-	LED Lamp DC 12V (14 CHIPS * 2EA)
Convertible Room Lamp		-	-
Door S/W(HOME BAR)		-	-
Door S/W		AC 125V,11A / 250V,11A	AC 125V,11A / 250V,11A
Power Cord		AC 125V, 15A	AC 125V, 15A
Earth Screw		BSBN (Brass Screw)	BSBN (Brass Screw)
MAIN S/W		AC 250V 16A	AC 250V 16A
Interlock S/W (ICE ROOM)		AC 125V,11A / 250V,11A	AC 125V,11A / 250V,11A

Electric Components

PRODUCT SPECIFICATIONS

2-2) Dimensions of Refrigerator (Inches)

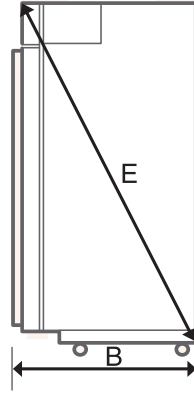
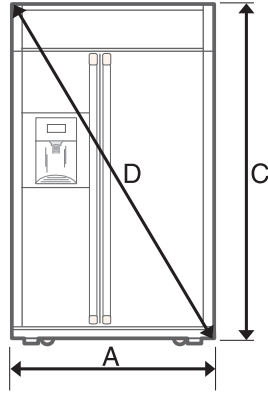

DOOR 90° OPEN

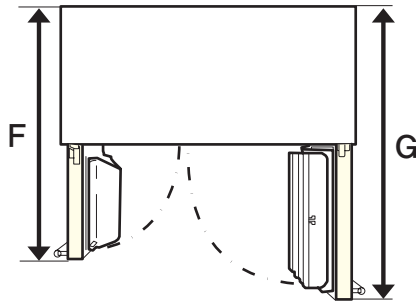

DOOR 135° OPEN

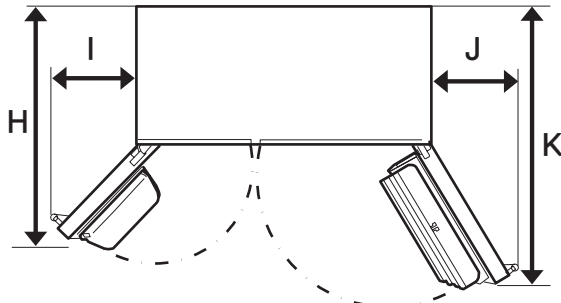

(inches)

MODEL	Front and side dimensions					Dimensions with doors open					
	A	B	C	D	E	F	G	H	I	J	K
DYF42SBIWS	42 (1067mm)	28.3 (720mm)	83.5 (2121mm)	93.5 (2374mm)	86.8 (2204mm)	42.5 (1079mm)	48.4 (1229mm)	39.2 (995mm)	13.5 (343mm)	17.7 (449mm)	43.3 (1101mm)

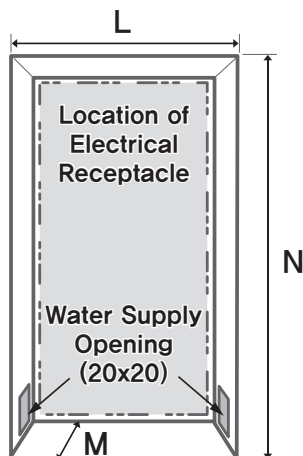

(inches)

MODEL	Enclosure dimensions		
	L	M	N
DYF42SBIWS	42 (1067 mm)	24 (610 mm)	84 (2134mm)

PRODUCT SPECIFICATIONS

2-3) Refrigeration Cycle

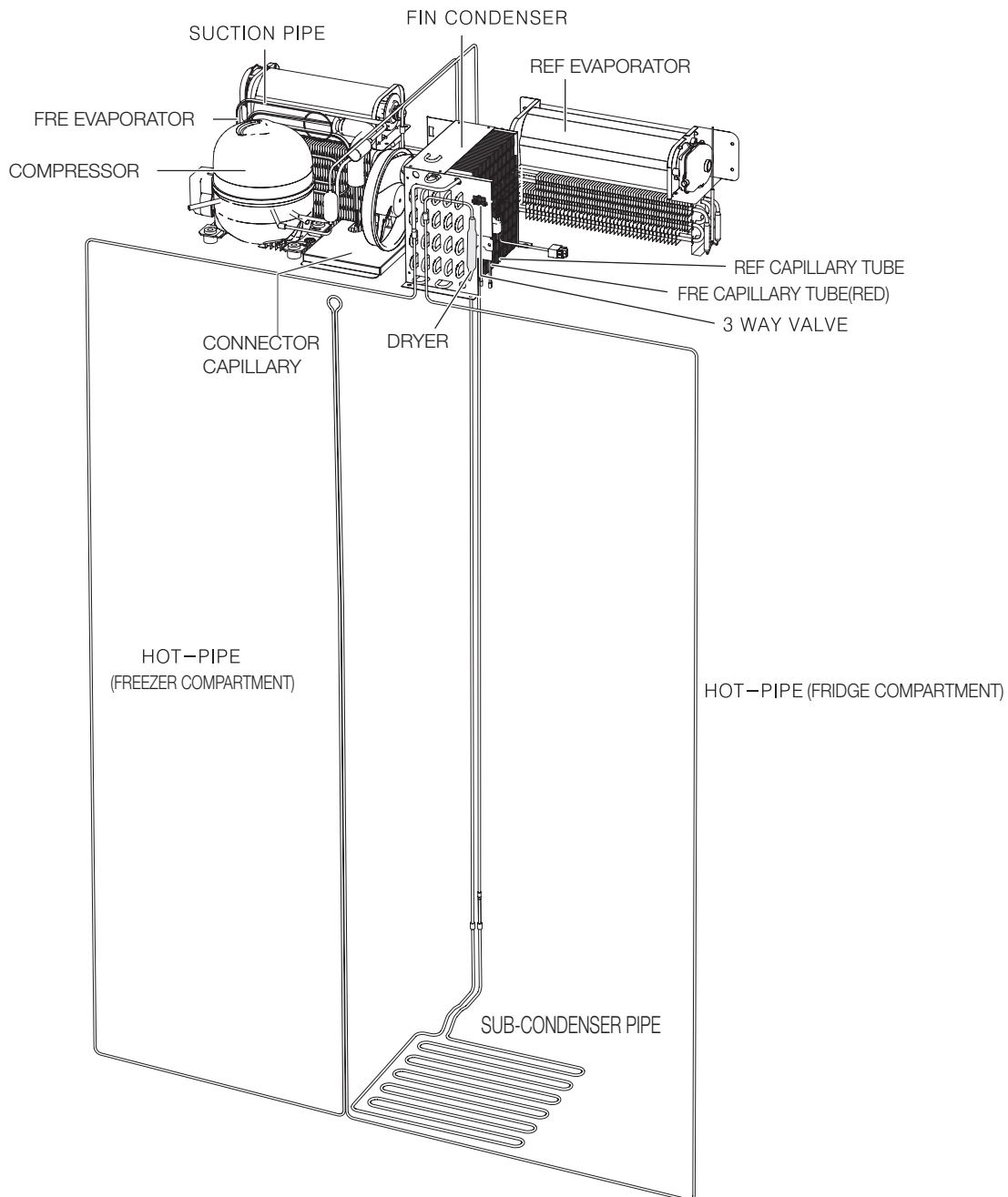
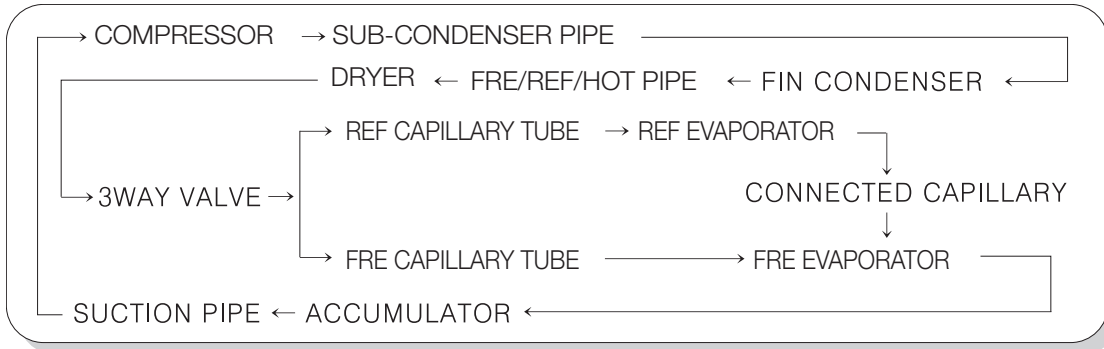

PRODUCT SPECIFICATIONS

2-3-1. Cold Air Circulation

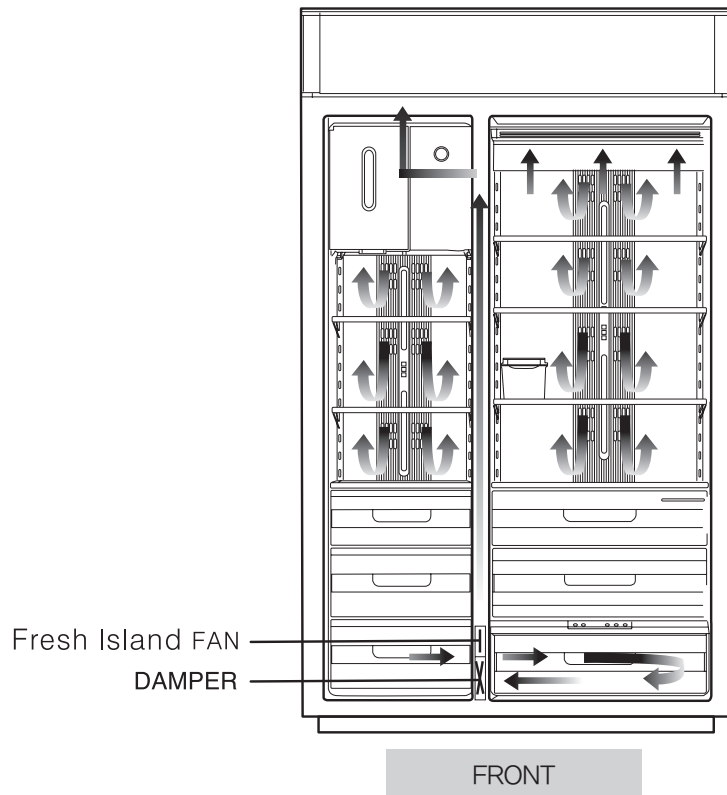
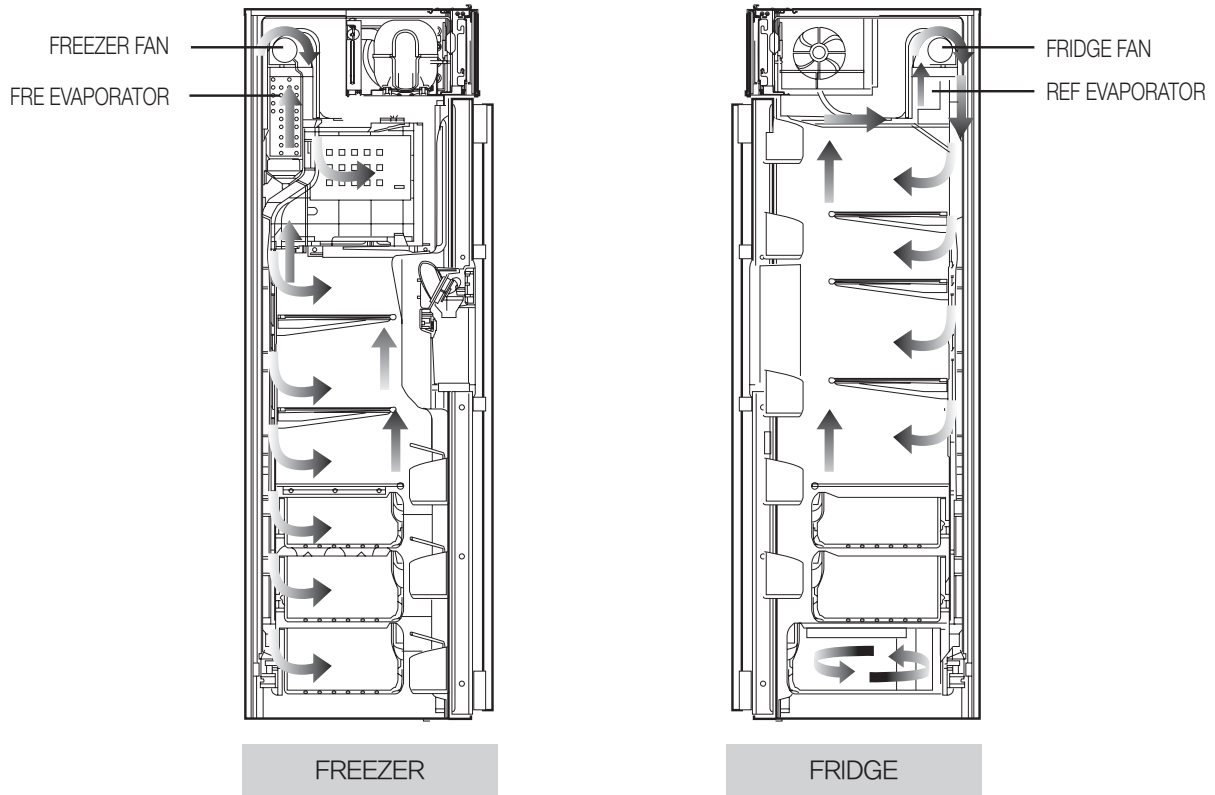

3. FULL DISASSEMBLY AND ASSEMBLY





3-1) PRECAUTION	16
3-2) How to Disassemble Each Component for A/S	17
3-3) Dispenser Cover	18
3-4) Handle & Cover Comp & Freezer Door.....	20
3-5) Interior Overview.....	21
3-6) Bin & Shelf & Drawer	22
3-7) Ice Maker & Evap.....	23
3-8) Duct & Rail	26
3-9) Unit & Pcb Box	28
3-10) Motor Damper.....	29
3-11) Heater & Water Valve.....	30

FULL DISASSEMBLY AND ASSEMBLY

3-1) PRECAUTION

- Unplug the refrigerator before cleaning and making repairs.
- Do not disassemble or repair the refrigerator by yourself.
 - It may cause risk of causing a fire, malfunction and/or personal injury.
- Remove any foreign matter or dust from the power plug pins.
 - Otherwise there is a risk of fire.
- Do not use a cord that shows cracks or abrasion damage along its length or at either end.
- Do not plug several appliances into the same multiple power board. The refrigerator should always be plugged into its own individual electrical which has a voltage rating that matched the rating plate.
 - This provides the best performance and also prevents overloading house wiring circuits, which could cause a fire hazard from overheated wires.
- Do not install the refrigerator in a damp place or place where it may come in contact with water.
 - Deteriorated insulation of electrical parts may cause an electric shock or fire.
- The refrigerator must be grounded.
 - You must ground the refrigerator to prevent any power leakages or electric shocks caused by current leakage from the refrigerator.
- Do not put bottles or glass containers in the freezer.
 - When the contents freeze, the glass may break and cause personal injury.
- Do not store volatile or flammable substances in the refrigerator.
 - The storage of benzene, thinner, alcohol, ether, LP gas and other such products may cause explosions.

- Required Tools

IMAGE	ITEM	USE
	Phillips Head Driver	Use for assembling and disassembling of screw
	Flat Head Driver	Use for assembling and disassembling of HomeBar, Dispenser, Deli Cartessen Box, Main PBA etc...
	Socket Wrench ϕ 10mm (3/8")	Use for assembling and disassembling of Door Hinge
	Spanner	Use for assembling and disassembling of Door Auto-Closer

FULL DISASSEMBLY AND ASSEMBLY

3-2) How to Disassemble Each Component for A/S

 Make sure to turn the refrigerator off before disassembling the components as shown below.

1) The descriptions of external parts are illustrated in the figure below, and the methods of disassembling the parts are indicated in order for you to refer to the relevant page, assigned to each number below.

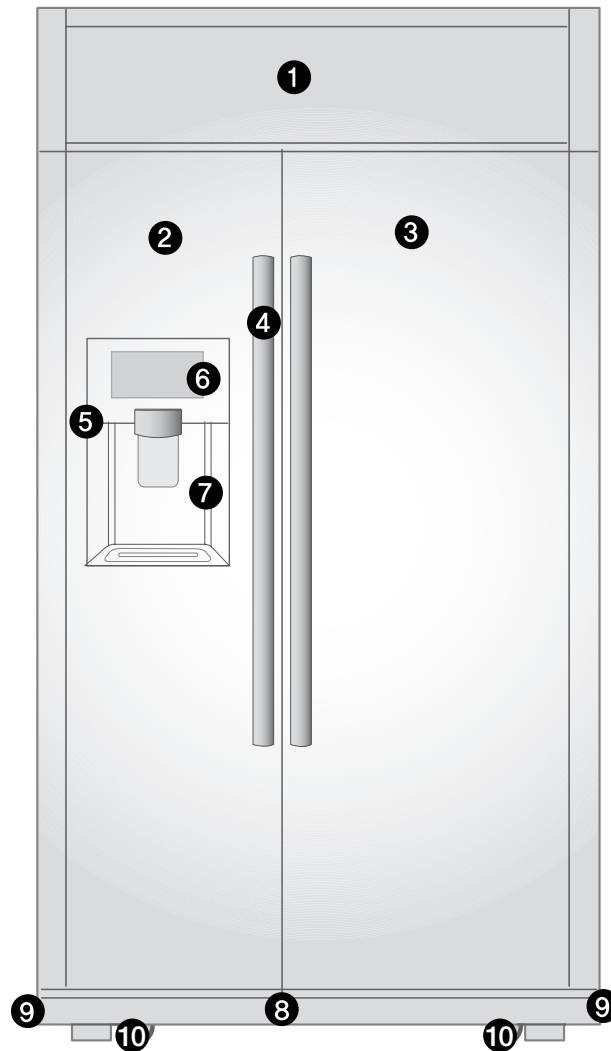

NO	Description
①	Machine Compartment Cover
②	Freezer Door
③	Fridge Door
④	Door Handle
⑤	Dispenser

NO	Description
⑥	Display
⑦	Dispenser Lever
⑧	Kick-Plate
⑨	Hinge
⑩	Leg

FULL DISASSEMBLY AND ASSEMBLY

3-3) Dispenser Cover

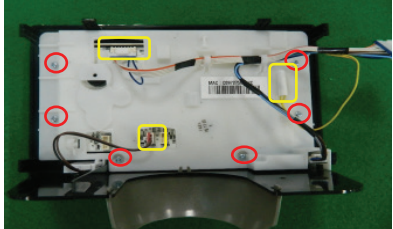
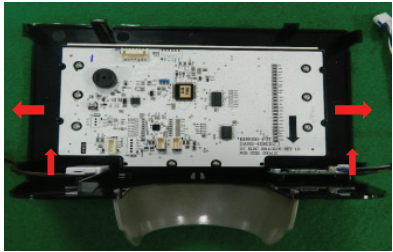
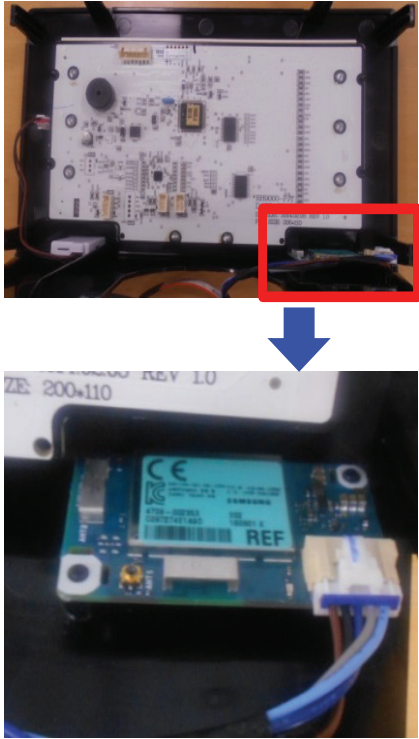
Part Name	How To Do	Descriptive Picture
<p>DISPENSER – COVER PCB</p>	<p>1. After referring to the Dispenser–Display Disassembly, remove the 6 screws after separating the 2 Connectors (Lamp Connector, Wifi Connector) and Temp sensor to disassemble the Display Cover.</p>	
	<p>2. Lift up the PBA, Lamp, Wifi module in the arrow direction and remove it.</p>	
	<p>3. Wifi module</p>	

FULL DISASSEMBLY AND ASSEMBLY

Part Name	How To Do	Descriptive Picture
DISPENSER – DISPLAY	<ol style="list-style-type: none"> ① Loosen the one screw at the bottom of display and remove deco cover. ② Push (-)driver between display and assy case ice route, pull out the assy case ice route to the front. ③ Disconnect the connector. 	
DISPENSER – Ass'y COVER ICE ROUTE	<ol style="list-style-type: none"> ① Disconnect the wires and hoses from the assembly. ② Loosen the circled 2 screws. ③ Push the shown in two hook in the direction of Inside, and pull out the assy case ice route to the front. 	
DISPENSER – PUSH LEVER MICRO SWITCH	<ol style="list-style-type: none"> ① Hold the lever as shown in the picture. ② Squeeze your four fingers into the gap on the top right side and pull it. ③ Disconnect Micro Switch. 	

FULL DISASSEMBLY AND ASSEMBLY

3-4) Handle & Cover Comp & Freezer Door

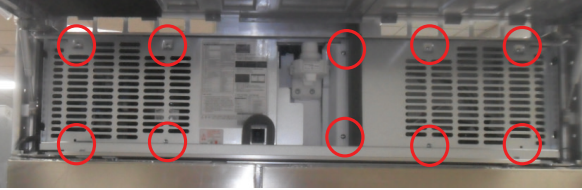
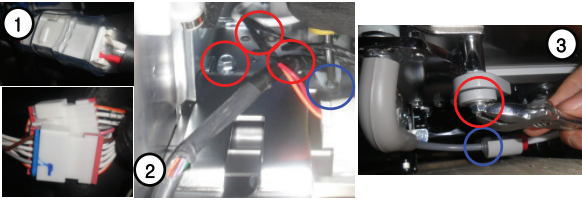
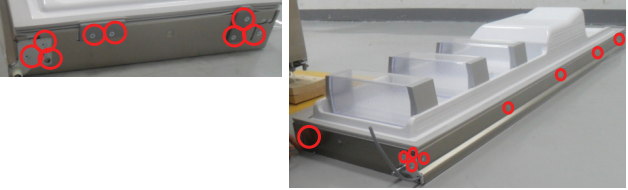
Part Name	How To Do	Descriptive Picture
ASSY-COVER COMP	<p>① After opening the Assy Grill, disassemble 10 screws and pull out the Cover.</p>	
DOOR	<p>① Disconnect the 3 housings inside of Machine Compartment. ② Disassemble circled 1 screw(blue) and 3 Bolts(red) on the upper hinge. ③ Disassemble the circled 1 bolt(red) and Water Hose(blue) under the Lower Hinge.</p>	
COVER DOOR	<p>① Disassemble 17 Screws On the Door(Top, Bottom, Side)</p>	

FULL DISASSEMBLY AND ASSEMBLY

3-5) Interior Overview

The descriptions of internal parts are illustrated in the photo below and refer to the pages below for disassembling each part. For the parts not illustrated in the photo, refer to the exploded view.

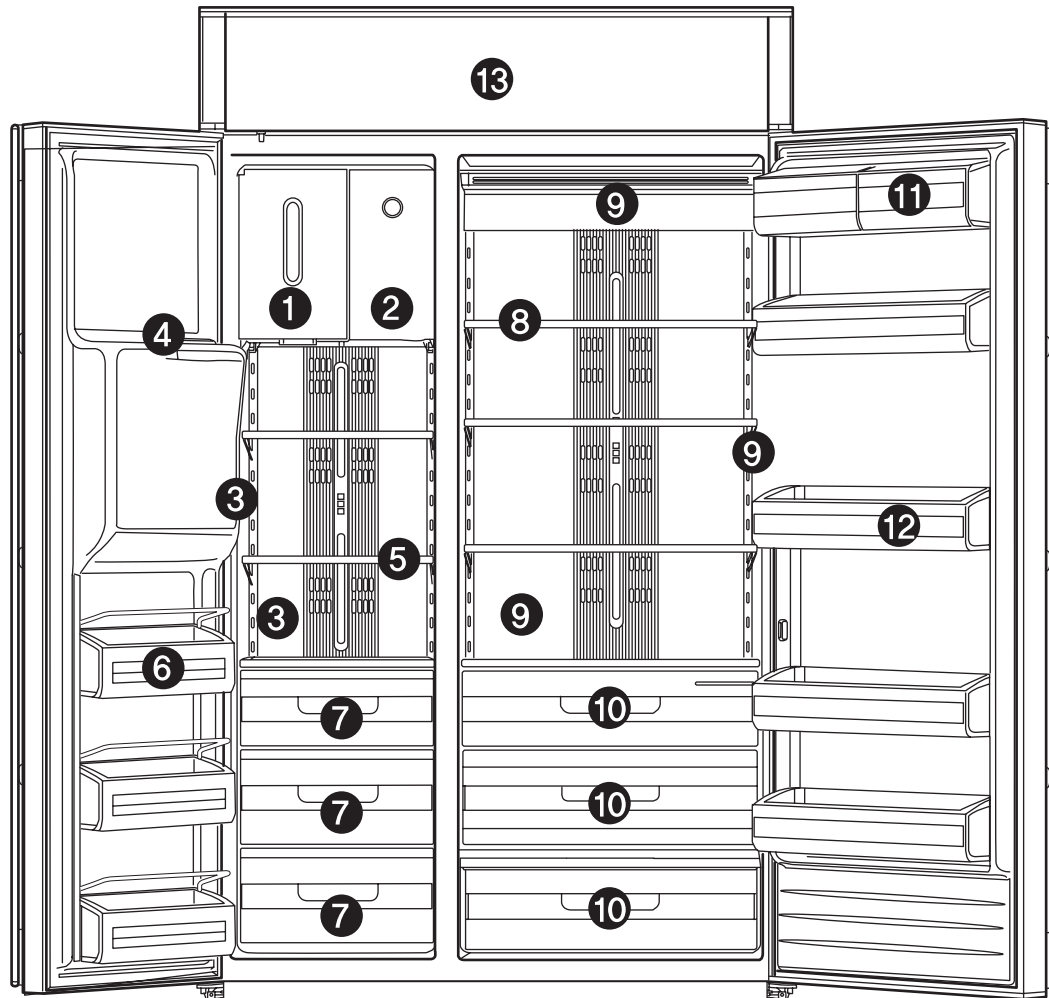

NO	Description
----	-------------







- ① Ice Storage Bin
- ② Freezer Storage
- ③ F-Room Lamp
- ④ Ice Chute
- ⑤ F-Room Shelf
- ⑥ F-Room Utility Bin
- ⑦ Dry Room/ Meat Drawer

NO	Description
----	-------------

- ⑧ R-Room Shelf
- ⑨ R-Room Lamp
- ⑩ Veg/Fruit Drawer
- ⑪ Dairy Bin
- ⑫ R-Room Utility Bin
- ⑬ Grille Panel

FULL DISASSEMBLY AND ASSEMBLY

3-6) Bin & Shelf & Drawer



Part Name	How To Do	Descriptive Picture
Ice Storage Bin	<p>① Hold the bottom of the left long slot with your hand, lift up and pull forward to remove it.</p> <p>● Not dispensing ice for long periods may cause ice clumps in the ice bucket.</p> <div style="display: flex; align-items: center;">  <div style="margin-left: 10px;"> <p>– Lift up and pull out the ice bucket to discard remaining clumps.</p> <p>– When replacing the ice bucket, be sure to press it firmly into place.</p> </div> </div>	
R-Room – Dairy Bin Cover	<p>① Flip the cover up and push it back to the direction as indicated with the arrow marks, and lift it up to remove it.</p>	
Dairy Bin	<p>① Lift Dairy Guard up with both hands and remove it.</p>	
Shelf (Common to R- and F-Room)	<p>① Hold the shelf with one hand and lift the rear up with the other hand, and pull it forward.</p>	
Drawer (Common to R- and F-Room)	<p>① Pull forward until it stops at the retaining hook, then lift it up and pull out. Make sure not to damage the door gasket with the sharp corners of the draw.</p>	

FULL DISASSEMBLY AND ASSEMBLY

3-7) Ice Maker & Evap

Part Name	How To Do	Descriptive Picture
<p>Ice Maker</p>	<ol style="list-style-type: none"> ① Remove the Ice Storage Bin then lift up the cover of Winter Closet to the direction of the arrow mark to remove. (Insert the spring into its seat when assembling it again.) ② Pull the partition out with the center of the shelf pressed down as shown in the photo, and remove the 2 screws below at the right left sides to disassemble the Auger Motor Ass'y. Pull the Ass'y out slightly to remove the wire housing on the rear left of the auger motor. ③ Loosen the 2 screws above the Ice Maker and the power cord housing, pull the Ice Maker Kit beside direction to disassemble. ④ Lift up the rear cover of the Auger Motor Ass'y to disassemble. When replacing the Ice Maker Geared Motor, remove the 2 screws indicated with the arrow marks in the photo. ⑤ When replacing the Auger Motor, remove the 4 screws indicated with the arrow marks and remove the hexnut at the motor axis to take the motor body and the rotation blade apart, finally remove the housings off the parts to replace. 	
<p>F-Room Evaporator</p>	<ol style="list-style-type: none"> ① Loosen the 4 screws to remove the upper cover of the F-Room remove the screw from the cover of the F-Room Evaporator after taking out the screw cap. To remove the cover, only remove the screw on the inner side of the auger motor support and have the support hanging. 	

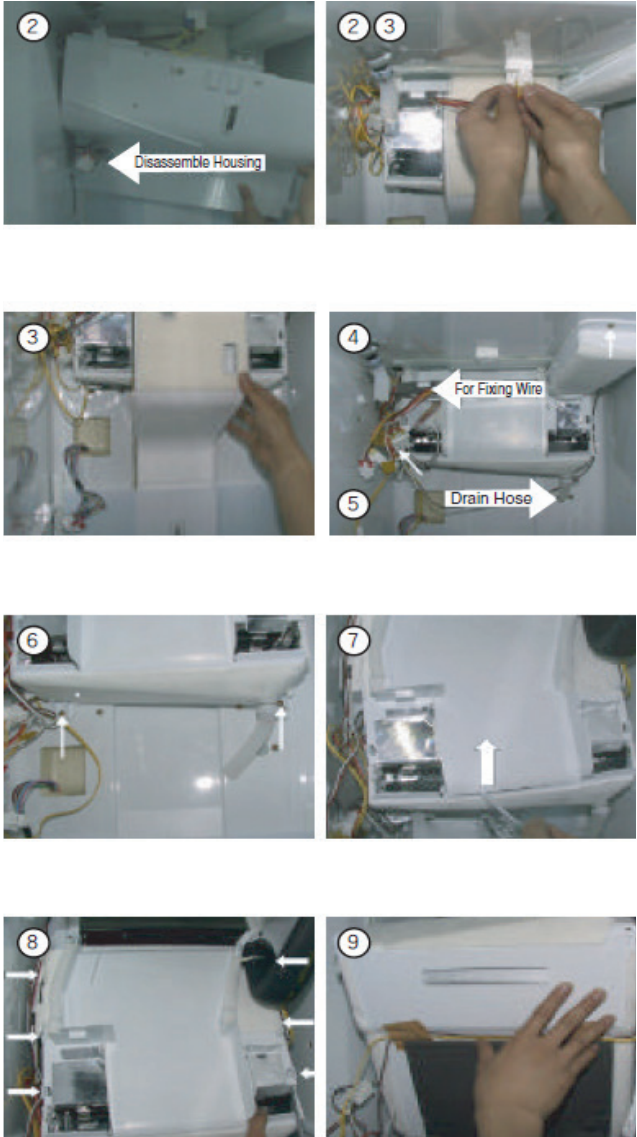
FULL DISASSEMBLY AND ASSEMBLY

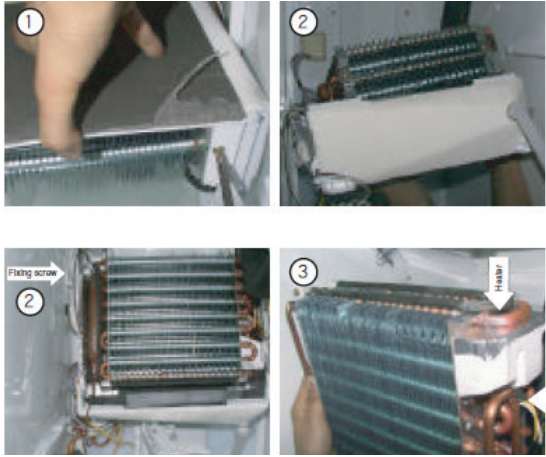

Part Name	How To Do	Descriptive Picture
<p>F–Room Evaporator</p>	<p>② After removing the housing from the left wall and the sensor housing on the upper side, pull the evaporator cover out as shown in the photo.</p> <p>③ Remove the fan motor housing and the heater housing, and pull the upper duct out from the F–Room.</p> <p>④ You can remove the flexible pipe drain heater off the evaporator after removing the 2 screws and the power cord housing indicated with the arrow mark.</p> <p>⑤ Pull the drain hose out, put it aside and remove the wire holder.</p> <p>⑥ Remove the 2 screws that hold the evaporator case, and lower the evaporator down slowly in order not to have the flexible pipe bend.</p> <p>⑦ Release the wire from its retainer and pull the bottom side of the evaporator cover down as shown in the photo.</p> <p>⑧ Release the six retaining hooks from both walls using a flat–blade screwdriver and take the front cover apart.</p> <p>⑨ Turn the evaporator slowly upside down so the flexible pipes are kept in line.</p>	
<p>F–Room Evaporator – Fan Motor Ass’y</p>	<p>① Refer to the F–Room Evaporator Disassembly loosen the 4 motor clamp screws as shown in the right photo to remove the Motor Ass’y.</p>	

FULL DISASSEMBLY AND ASSEMBLY

Part Name	How To Do	Descriptive Picture
F-Room Evaporator - Defrost Heater/ Bimetal/ Defrost Sensor	<p>① F-Room Evaporator – After removing the Fan Motor Ass’y as shown in the photo, remove the clamp screw holding the evaporator.</p> <p>② Turn the evaporator over again to pull it out from its case.</p> <p>③ If necessary, remove Defrost Heater/Bimetal/Defrost Sensor by removing the clamp screws and the clips.</p>	 <p>The descriptive picture consists of four numbered photographs illustrating the removal process:</p> <ul style="list-style-type: none"> Photo 1: A hand is shown removing a clamp screw from the evaporator. Photo 2: The evaporator is shown being turned over to pull it out from its case. Photo 3 (top left): Shows the evaporator with a label 'Fixing screw' pointing to a screw on the left side. Photo 3 (bottom right): Shows the evaporator with a label 'Heater' pointing to a component on the right side.

FULL DISASSEMBLY AND ASSEMBLY

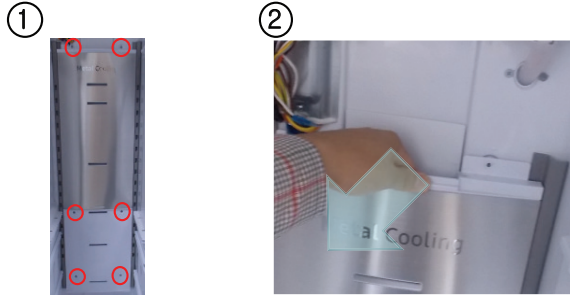
3-8) Duct & Rail

Part Name	How To Do	Descriptive Picture
F-Room - Duct	① Remove the 6 clamp screws ② Pull the upper part of the F-Room Duct	
Rail (Common to R-and F-Room)	① Refer to the drawer disassembly to remove drawers. ② Remove the screws.	

FULL DISASSEMBLY AND ASSEMBLY

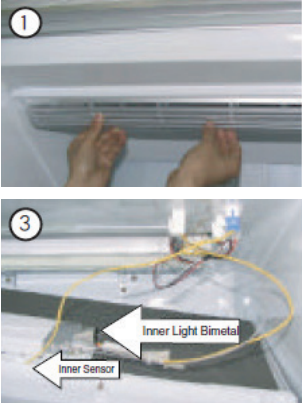
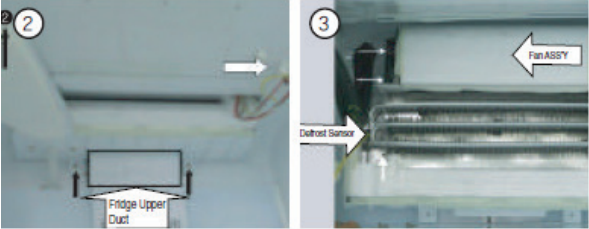
Part Name	How To Do	Descriptive Picture
<p>R–Room Sensor</p>	<ol style="list-style-type: none"> ① Disassemble the front Intake Grille from the retaining hook at the back. ② Remove the 5 screws to disassemble the upper cover of the R–Room, and unscrew the housing to remove the sensor. 	 <p>Caution Make sure to atch the housing colors. If not, it can cause a fire.</p>
<p>R–Room Evaporator</p>	<ol style="list-style-type: none"> ① Refer to how to remove the R–Room Sensor to remove the upper cover of R–Room, the drain cover and the housing. ② Remove the screws on the upper duct indicated with a arrow to disconnect the upper duct and remove the 2 screws that secure the evaporator. Then, lower the evaporator down slowly in order not to have the pipe bend. Remove the front evaporator cover to disassemble the relevant parts as shown in the photo. ③ To remove the Fan Ass’y, remove the 4 screws that hold the Fan then disassemble the housing. ④ To remove the bimetal,remove the clamp screws and pull the housing out. ⑤ Pull the Defrost Sensor out of the hole in the left side plate 	 <p>Caution Make sure to have the lastic bag to wrap the housing assembled with its opening face down in order not to gather moisture or water.</p>

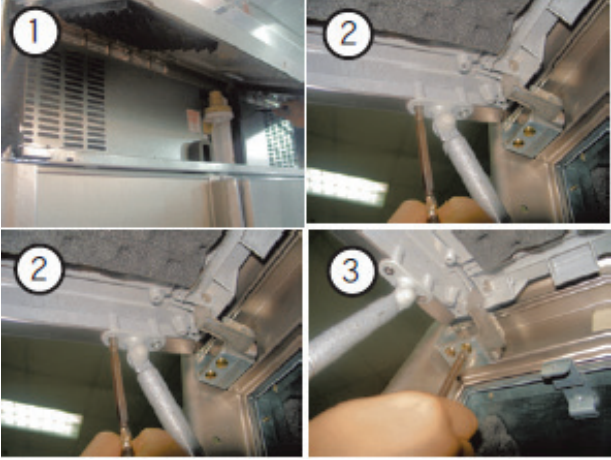
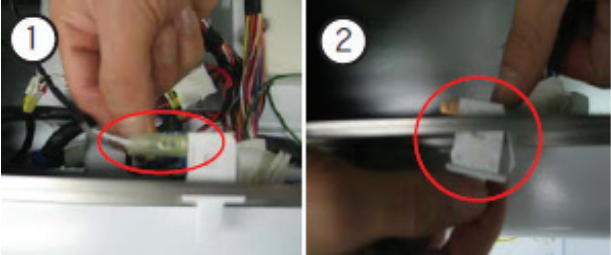
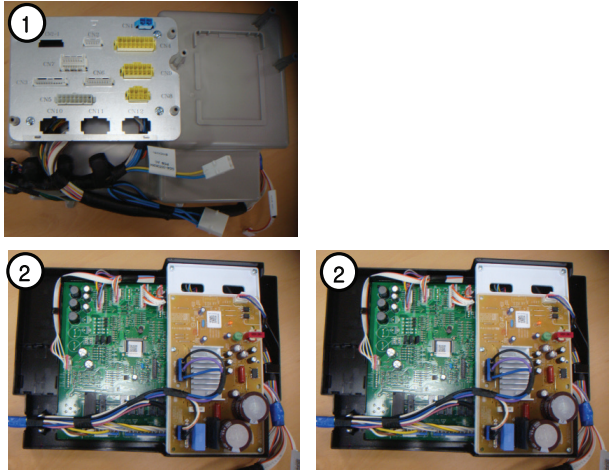

FULL DISASSEMBLY AND ASSEMBLY

3-9) Unit & Pcb Box

Part Name	How To Do	Descriptive Picture
MACHINE COMPARTMENT	<p>① Right figure displays the Machine Compartment.</p>	
ASSY-GRILLE, GAS SPRING	<p>① Open the Assy-Grille and remove Assy-cover comp. ② Remove gas struts from the stud by loosening the clip of the strut with a screw driver. ③ Unscrew two screws off the gas struts and the other two screws from the hinge.</p>	
DOOR SWITCH	<p>① Disassemble Cover Grill, disassemble the Housing of the switch. ② Disassemble the switch pulling down</p>	
PCB-BOX	<p>① Pull out Housing connected to the terminal block, second remove 2 screws, third disassemble ground wire and finally pull out PCBBOX Cover. ② After opening PCB-BOX Cover, pull out Housing and disassemble 4 screws to remove SMPS. ③ Disassemble Main PCB from PCB-BOX. ※ Main PCB should be fixed to a hook like figure.</p>	

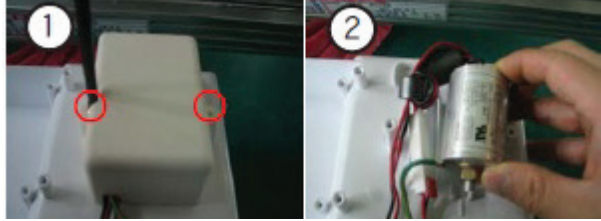
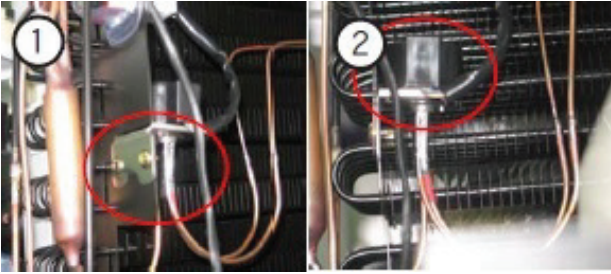
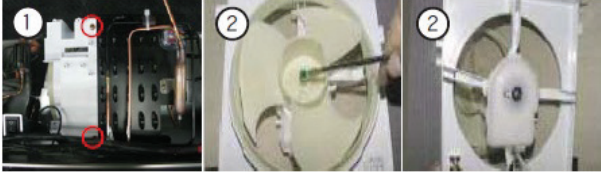
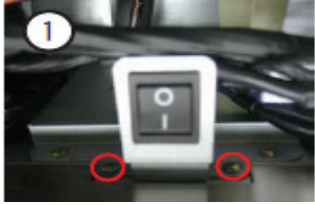

FULL DISASSEMBLY AND ASSEMBLY

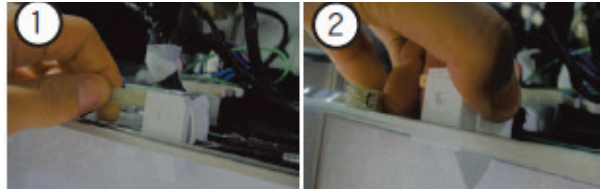
3-10) Motor Damper

Part Name	How To Do	Descriptive Picture
PCB-BOX : CONDENSER	① Disassemble circled 2 screws. ② Pull out Condenser from PCB-BOX. ※ Be careful do not change the terminals during assembly.	
3-WAY VALVE	① Disassemble the Cover Grill, disassemble the 3 welded sections. ② Disassemble 3-way Valve then disassemble 2 screws and pull out Housing. ※ Be careful do not change the pipe during assembly (red one is for Freezer) Wrong connection of pipes alter the gas flow and cause performance issues.	
CONDENSER FAN MOTOR	① Pull out Fan Ass'y refer to figure disassemble circled 2 screws. ② First disassemble the locking spring of Fan, second disassemble 2 screws for mounting Motor Cover, third disassemble the wire Housing and then pull out the Motor by rotating it.	
POWER SWITCH	① Disassemble (circle)2 screws mounting bracket and Housing connected to PCB-BOX then pull out Power switch from the bracket.	
INSULATION COVER OF CONNECTING PIPE	① Disassemble 5 screws located at the back of Power switch. ② The pipes are covered with insulation tubing left is for Freezer, right is for Fridge.	
DOOR SWITCH	① After disassembling Cover Grill, disassemble the housing of switch like in the Figure. ② Disassemble the switch by a pulling down with squeezing the lock hooks.	

FULL DISASSEMBLY AND ASSEMBLY

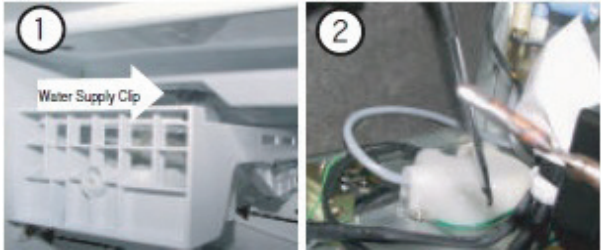
3-11) Heater & Water Valve

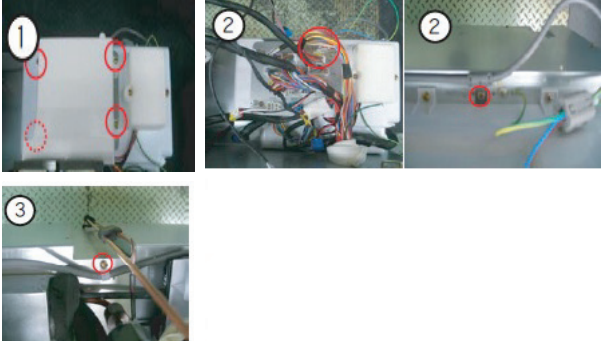
Part Name	How To Do	Descriptive Picture
HEATER-WATER PIPE	<ol style="list-style-type: none"> ① After disassembling Ice Maker, disassemble the clip of supply water hose. ② Disassemble 2 screws pull out the cover. ③ If needed, disassemble the Heater Ass'y after disassembling supply water hose. 	
WATER VALVE	<ol style="list-style-type: none"> ① Turn off Water supply, disassemble Cover Grill then, disassemble the wire Housing of the Water Valve located at the left back. ② Disassemble hex nut supply hose using wrench. ③ Disassemble Water Valve after disassembling the bracket and screw which secure the Water Valve. 	
POWER CORD	<ol style="list-style-type: none"> ① Disassemble Cover Grill, disassemble the circled 4 screws for mounting Housing Cover. ② Pull out the Housing of the Power Cord located at the top of the terminal block. ③ Disassemble (circled) 2 screws located at the top of the machine compartment. 	

4. FUNCTION FOR FAILURE DIAGNOSIS

4-1) Test mode (manual operation / manual defrost function)	32
4-2) Display function of Communication error	33
4-3) Self Diagnostics function.....	33
4-4) Load Status Check function	36
4-5) Wi-fi(Network) Module Check Function.....	38
4-6) How to Access the AP Mode and register your Smart Home Product.....	39
4-7) MAC Address Display Mode	39
4-8) Refrigerator Option (Service Mode) function	40
4-9) Option TABLE.....	42
4-10) Diagnostic method according to the trouble symptom (Flow Chart).....	47

FUNCTION OFR FAILURE DIAGNOSIS

4-1) Test mode (manual operation / manual defrost function)

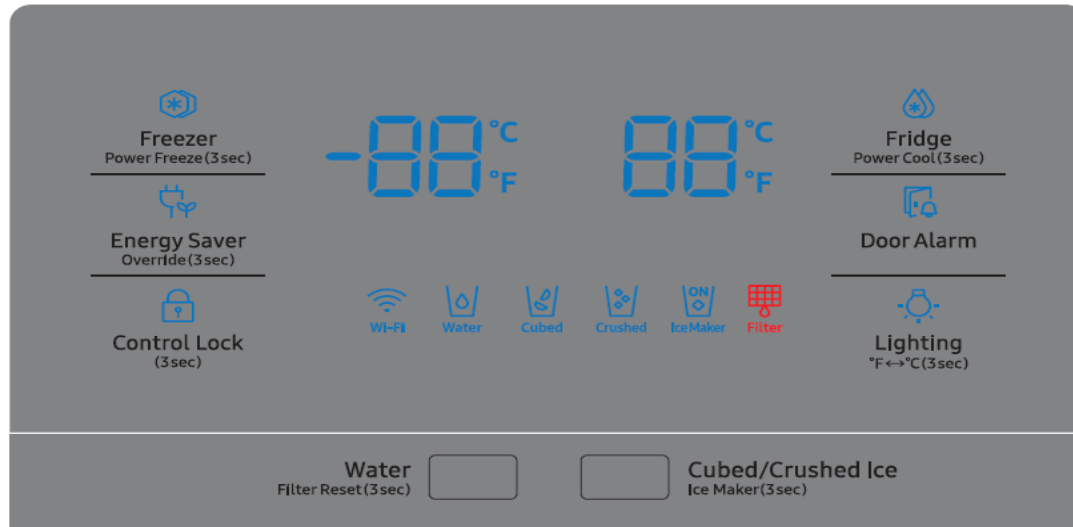

- If Freezer Key + Alarm Key on the front of panel are pressed simultaneously for 8 seconds
- It will be changed to the test mode and all displays on the front of panel will be off.
- If any key on the front of panel is pressed within 15 seconds after the test mode, it will be operated as below sequence : Manual operation (FF) → manual operation (FF-r) → manual operation (FF-F) → manual operation (FF-A) → manual defrost of fridge compartments(rd) → manual defrost of freezer compartment(Fd) → cancel(Display all off)
- If any key on the front of panel is not pressed within 15 seconds after the test mode, the test mode will be canceled and it will be returned to previous mode.

1) Manual operation function

DISPLAY	Operating Time	Operation			
		F-Fan (Freezer)	R-Fan (Fridge)	F-Valve	R-Valve
FF	24hr	ON	Temperature Control	Swing	Swing
FF r	24hr	OFF	ON	OFF	ON
FF F	24hr	ON	OFF	ON	OFF
FF A	24hr	ON	ON	ON	ON

2) Forced Defrost

Rd : Forced Fridge Compartment defrosting (rd) begins, a beeping sound will be heard for 2 seconds and then the sound will be turned on for 0.1 seconds and then off for 0.9 seconds repeatedly while the Forced defrosting function runs.

Fd : Forced Freezing, Fridge Compartment defrosting (Fd) begins, a beeping sound will be heard for 2 seconds and then the sound will be turned on for 0.5 seconds and then off for 0.5 seconds repeatedly while the Forced defrosting function runs.

3) Test cancel mode

During the defrosting of freezer compartment if the display panel change to the test mode and test button is pressed one more time, defrosting of freezer compartment will be canceled and the unit will return to the normal operation.

Or, all test functions will be canceled by turning main power ON and OFF.

FUNCTION OF FAILURE DIAGNOSIS

4-2) Display function of Communication error

- 1) Display function when Panel ↔ MAIN MICOM communication has error.
 - 1-1) If there is no answer for 10 seconds after the panel micom received the requirement of communication, "PC-Ch" display on the panel PCB will be ON/OFF alternately until the communication error is canceled. (0.5 sec ALL ON, 0.5 sec ALL OFF alternately)



- 1-2) "PC-Ch" display on the Panel Display will be ON/OFF alternately until the communication error is canceled. (0.5 sec ALL ON, 0.5 sec ALL OFF alternately)

- 2) Display function when Panel ↔ MAIN MICOM OPTION has error
 - 2-1) "oP-Ch" code is repeatedly ON/OFF until Option error settles down.

4-3) Self Diagnostics function

- 1) Self-diagnostic function in the Initial power ON
 - 1-1) Micom operates self-diagnostic function to check the temperature sensor condition within 1 second when the refrigerator turned On initially.
 - 1-2) If bad sensor is detected by the self-diagnostic function, the applicable display LED will blink for 0.5 sec. At this moment, there is no beep sound.(Refer to self-diagnostic CHECK LIST)
 - 1-3) Self-diagnostic button is recognized only when the error is displayed by the bad sensor. Display does not operate normally but temperature control will be controlled by the emergency operation.
 - 1-4) When the error is detected by self-diagnosis, the error can be canceled automatically if all troubled sensors are corrected or Self-diagnostic function key Freezer Key + Fridge Key are pressed simultaneously for 8 seconds (Return to normal display mode)
- 2) Self-diagnostic function during normal operation
 - 2-1) If Freezer Key + Fridge Key are pressed simultaneously for 6 seconds during normal operation, the temperature setting display will operate for 2 seconds (ON/OFF 0.5sec each).
If Freezer Key + Fridge Key are pressed simultaneously for 8 seconds (including above 2 seconds), self-diagnostic function will be selected.
 - 2-2) At this moment, self-diagnostic function will be returned with buzzer sound.
If there is an error, display of error will be operated for 60 seconds and then return to normal condition whether problem is corrected or not. (Refer to self-diagnosis CHECK LIST)
 - 2-3) Input by button is not accepted during self-diagnostic function.

FUNCTION OFR FAILURE DIAGNOSIS

※ Self-diagnostics check list

LED	Item	Trouble contents	Diagnostic method
1	F-Sensor Error	Slipped out Sensor Housing, Wire-Cut, Wire-Short, When the sensor pickup temp is over +50°C or under -50°C, Error occurs.	The voltage between Case Connector CN2 #1 ↔ #5 should be within 4.5V~1.0V
2	R-Sensor Error		The voltage between Case Connector CN3 #1 ↔ #3 should be within 4.5V~1.0V
4	F-Def Sensor Error		The voltage between Case Connector CN2 #1 ↔ #6 should be within 4.5V~1.0V
5	R-Def Sensor Error		The voltage between Case Connector CN3 #2 ↔ #3 should be within 4.5V~1.0V
6	Ambient Sensor Error		The voltage between Case Connector CN5 #7 ↔ #13 should be within 4.5V~1.0V
8	Ice Maker Sensor Error		The voltage between Case Connector CN90 #3 ↔ #9 should be within 4.5V~1.0V
13	Humidity Sensor Error		The voltage between Case Connector CN7 #13 ↔ #15 should be within 4.5V~1.0V
21	F-Fan Error		When the related Fan Motor operates, it occurs if the contact of the Feed Back Signal Wire is defective, the Motor Wire is slipped out or the Motor is defective.
22	R-Fan Error	The voltage between Case Connector CN3 #3 ↔ #4 should be within 7V~12V	
23	C-Fan Error	The voltage between Case Connector CN7 #10 ↔ #11 should be within 7V~12V	
24	F-Defrost Error	Display error during operation of applicable fan motor : Feed back signal line contact error, motor wire separation, motor error	Since the F-Defrost Heater is linked with the Drain Heater and the Sub Heater, it is not able to diagnose the part. So, check the status of the wire harness connection related to the F-Defrost Heater.
25	R-Defrost Error	Display error during operation of applicable fan motor : Feed back signal line contact error, motor wire separation, motor error	Since the R-Defrost Heater is linked with the Drain Heater and the Ice Maker Pipe Heater, it is not able to diagnose the part. So, check the status of the wire harness connection related to the R-Defrost Heater.
26	Ice Maker Function Error	When the Freezer Ice Maker error occurs more than 3 times, the error will be displayed.	After replacing the Ice Maker, check if it operates normal.

FUNCTION OFR FAILURE DIAGNOSIS

※ Self-diagnostics check list

LED	Item	Trouble contents	Diagnostic method
41	Communication Error between Main ↔ Panel	When there is no communication between MICOM MAIN ↔ PANEL for more than 10 seconds, the MICOM MAIN ↔ PANEL Communication Error Window will show on the Display.	To check its defect, a Oscilloscope is needed. So, replace the MAIN PCB and check if the problem persists.
44	Communication Error between Main ↔ Inverter	Display 44Er in the panel : Inverter MICOM ↔ Main MICOM communication error.	Actually, If there is not a problem, it is desirable to replace Main and Inverter PCB With the oscilloscope after a cable problem confirming.
46	Communication Error between Main ↔ I/O Expander	Display 46Er in the panel : I/O Expander ↔ Main MICOM communication error.	It is desirable to replace Main PCB.
71	Abnormal High Temperature of Freezer	The error occurs when the Freezer temperature rises abnormally or when the Freezer Door remains open for a while while the unit's inside temperature is high.	When its Door remains open for an extended time or high temperature food is stored, close the Door or take out the hot food. Then, after a while, the error will disappear.
72	Abnormal High Temperature of Fridge	The error occurs when the Fridge temperature rises abnormally or when the Fridge Door remains open for a while while the unit's inside temperature is high.	When its Door remains open for an extended time or high temperature food is stored, close the Door or take out the hot food. Then, after a while, the error will disappear.
81	Comp Startup Failure	When the Comp Startup Failure is detected	1. Short between Comp. U/V/W (CN04) 2. Short between IPM PIN (#1~26) 3. IPM Operation Voltage Dropdown (Lower than DC13.5V) 4. Check Comp and Cycle
82	Comp IPM Fault	When the Comp IPM Fault is detected	4. Check Comp and Cycle
83	Abnormal Current Pick-Up at Comp	When the Abnormal Current is pick-up at the Comp	1. Comp Connector Plugged Out (CN04) 2. R1 Defect or Assembly Defect 3. Check Comp and Cycle
84	Comp Motor Restriction	When the Comp Motor Restriction is detected	1. When the Comp is restricted for more than 5 seconds 2. When the Comp runs at lower than 1000RPM for over 5 seconds 3. R1 Short 4. Severe fluctuation of Input Voltage 5. Check Comp and Cycle
85	Comp Low Voltage	When the Low Voltage is detected at the Comp	1. Input AC Voltage 106V or lower 2. When R312 is short (DC Link Resistor)
86	Comp High Voltage	When the High Voltage is detected at the Comp	1. Input AC Voltage 310V or higher 2. When R309, R310 or R311 is short (DC Link Resistor)

FUNCTION OFR FAILURE DIAGNOSIS

4-4) Load Status Check function

- 1) If Freezer Key + Fridge Key are pressed simultaneously for 6 seconds during normal operation, the temperature setting display of fridge and freezer compartments will blink ALL ON/OFF with 0.5 for 2 seconds.
- 2) At this moment, If Alarm Key after Freezer Key + Fridge Key is pressed, load condition display mode will be returned with alarm. At LED all on state only load condition display will blink ON/OFF with 0.5 seconds interval.
- 3) Load condition display mode shows the load that micom signal is outputting. However, It means that micom signal is outputting, it does not mean whether load is operating or not. That is to say that though load operation is displayed, load could not be operated by actual load error or PCB relay error etc. (This function would be applied at A/S.)
- 4) Load condition display function will maintain for 30 seconds and then normal condition will be returned automatically.
- 5) Load condition display is as below. Only the load control LED will blink with 0.5 interval in "Display LED"

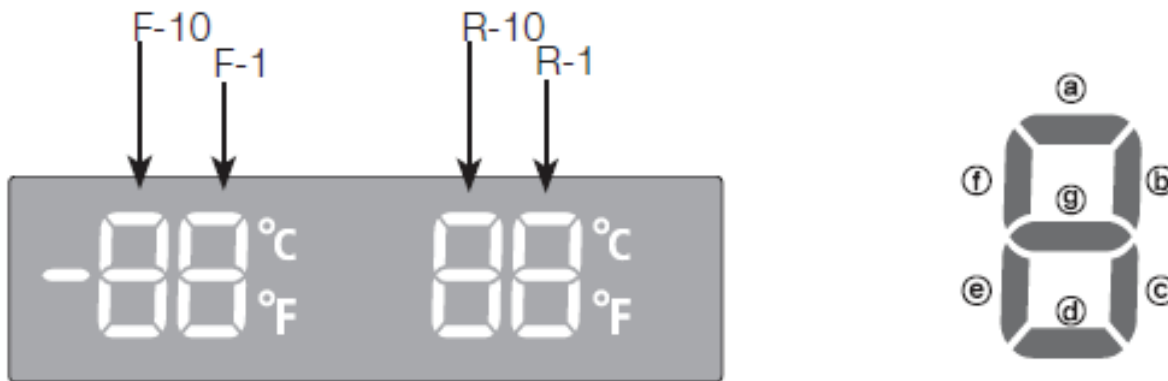

FUNCTION OF FAILURE DIAGNOSIS

※ Self-diagnostics check list

Display contents	Display (LED)	Operation contents
R-FAN HIGHEST	R-1-Ⓐ, Ⓑ	When R-FAN HIGHEST operates, applicable LED blinks.
R-FAN HIGH	R-1-Ⓐ	When R-FAN HIGH operates, applicable LED blinks.
R-FAN LOW	R-1-Ⓑ	When R-FAN LOW operates, applicable LED blinks.
R-DEF HEATER	R-1-Ⓒ	When R-DEF HEATER operates, applicable LED blinks.
Overload condition	R-1-Ⓔ	When ambient temperature is more than 93°F(34°C), LED blinks.
Low Temperature condition	R-1-Ⓛ	When ambient temperature is less than 70°F(21°C), LED blinks.
Normal condition	R-1-Ⓔ, Ⓛ (Not blinks ALL LED)	When ambient temperature is between 72°F(22°C) and 91°F(33°C)
Exhibition mode	R-1-Ⓘ	LED Blinks at the display mode
ICE MAKER FULL	R-10-Ⓓ	When the Ice Maker's Bucket is full, applicable LED blinks.
COMP	F-1-Ⓐ	When COMP operates, applicable LED blinks.
F-FAN HIGHEST	F-1-Ⓑ, Ⓒ	When F-FAN HIGHEST operates, applicable LED blinks.
F-FAN HIGH	F-1-Ⓑ	When F-FAN HIGH operates, applicable LED blinks.
F-FAN-LOW	F-1-Ⓒ	When F-FAN LOW operates, applicable LED blinks.
F-DEF HEATER	F-1-Ⓓ	When F-DEF HEATER operates, applicable LED blinks.
C-FAN HIGHEST	F-1-Ⓔ, Ⓛ	When C-FAN HIGHEST operates, applicable LED blinks.
C-FAN HIGH	F-1-Ⓔ	When C-FAN HIGH operates, applicable LED blinks.
C-FAN LOW	F-1-Ⓛ	When C-FAN LOW operates, applicable LED blinks.
F-VALVE	F-10-Ⓑ	When F-VALVE opens, applicable LED blinks.
R-VALVE	F-10-Ⓒ	When R-VALVE opens, applicable LED blinks.
DISPENSER HEATER	F-10-Ⓔ	When DISPENSER HEATER operates, applicable LED blinks.
WIFI Status	WIFI Icon	When AP and Internet Disconnect : LED OFF When AP connect and Internet Disconnect : LED Blinks When AP and Internet connect : LED ON

FUNCTION OFR FAILURE DIAGNOSIS

4-5) Wi-fi(Network) Module Check Function

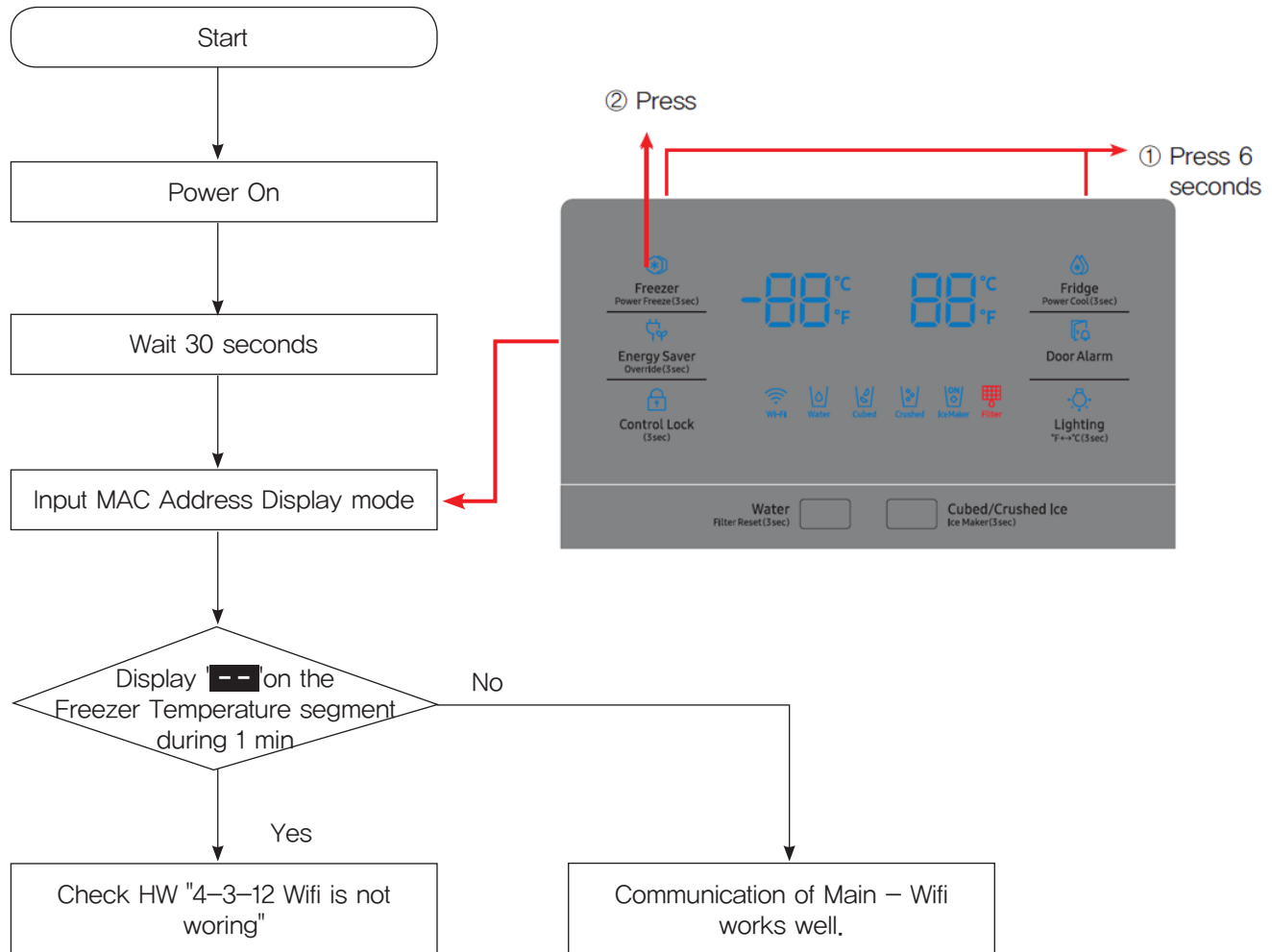

FUNCTION OFR FAILURE DIAGNOSIS

4-6) How to Access the AP Mode and register your Smart Home Product

- 1) Run the Smart Home application, press "+" (add device) in the "Device" screen, and select Refrigerator in the product list.
- 2) According to the guidance of the screen, enter the information of the wired/wireless sharer to be connected, and press the "Next" button.
(This is a step for connecting the Refrigerator and the wired/wireless sharer for product registration, and please follow the guidance of the application.)
- 3) Press the Fridge button on the display part of the Refrigerator for five seconds or longer.
(When three seconds have passed, Power Cool will be set. When two more seconds have passed, Power Cool will be canceled, and AP will be displayed.)
If "AP" is displayed on the Freezer Temperature Display part, start Easy Connection.
※ If Easy Connection is not performed on the smartphone, please retry this step.
- 4) The product registration is automatically performed through the Easy Connection, and when the product registration is completed, the Refrigerator icon will appear on the application screen.
(If you have failed during registration, please retry from the beginning.)
- 5) Select the registered Refrigerator icon.

4-7) MAC Address Display Mode

- 1) This function is to display the MAC address of the Refrigerator Wi-Fi module, and consecutively displays the MAC address on the Freezer (F Compartment) Temperature Display Part for one minute.
– If you press the Freezer button and the Fridge button simultaneously for six seconds or longer, the Display will blink.
Here, if you press the Freezer button, a buzzer sound will be made and the product will enter the MAC Address Display Mode.
- 2) If the MAC address is "11-22-33-44-55-66," "--," "11," "22," ... "66," and "--" will be repeatedly displayed on the Freezer Temperature Display Part for one minute.
When one minute has passed, the MAC Address Display Mode will be canceled with a buzzer sound, and the product will return to the normal Display Mode.
※ If the MAC address is not valid or the Wi-Fi module is not connected, "--" will be displayed on the Freezer Display Part for one minute.

FUNCTION OFR FAILURE DIAGNOSIS

4-8) Refrigerator Option (Service Mode) function

- Energy Saver Key + Fridge Key are pressed simultaneously for 12 seconds during normal operation, fridge and freezer compartments temperature display will be changed to option setting mode.

※ Key control in option mode

Freezer Key	Code Down Key
Energy Saver Key	Code Up Key
Fridge Key	Reference Value Down Key
Alarm Key	Reference Value Up Key

- If the display changes to option setting mode, all displays will be off except freezer and fridge compartments temperature display as below.
(Fridge and freezer compartments case will be explained only because all options are operated with the same method according to the option table.)

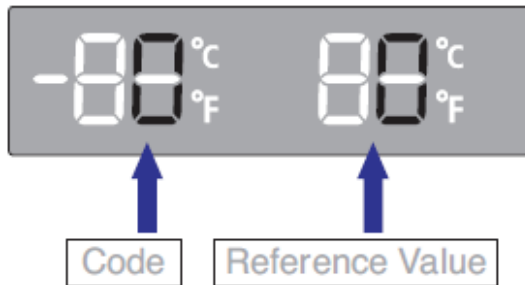

- 1) For example, if you want to change freezer compartment standard temperature to -4°F (-2°C) by operating option, do as below. This function is for changing the standard temperature.
In -2°F (-19°C) of current temperature of freezer compartment, if you make the temperature lower to -4°F (-2°C) by the option, the standard temperature would be controlled -6°F (-21°C). Therefore, if you change the setting of temperature option to -2°F (-19°C) on the panel, the appliance will be operated with -6°F (-21°C). It means that standard temperature is controlled -4°F (-2°C) less than setting temperature in the display.



NOTE

Basically, all the data in option has cleared from the factory. Therefore, almost all setting value are "0". But, some setting values could be changed for the purpose of improving performance. You need to check the product manual and/or specification.

- 2) After changing to the option mode, fridge compartment "0", freezer compartment "0" will be displayed. (Basically fridge compartment "0", freezer "0" would be set at shipping process, but setting value could be changed for the purpose of improving product at mass producing process.)
 - If fridge compartment "0" shows only, temperature reference value of freezer compartment will be set and current freezer compartment temperature code will be displayed on the freezer temperature display.

FUNCTION OFR FAILURE DIAGNOSIS

- 3) If freezer compartment "4" is set as below freezer compartment code after fridge compartment "0" is set, standard temperature of freezer compartment will be lower than -4°F (-2.0°C).
(Refer to the picture "changing the freezer compartment temperature")

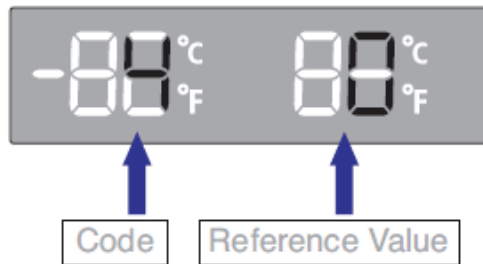

- : If you wait for 20 seconds after completing the setting, MICOM will save the setting value to the EEPROM and normal display will be returned and the option setting mode will be canceled.
- 4) Option changing method as above is the same as all model.
- 5) By the same method as above, it is possible to control the fridge compartment temperature, water supply, ice-maker harvest temperature/time, defrost return time etc.
- 6) Option function is set in the EEPROM at shipping process in the factory.
You would better not to change the option of your own.
Completing the setting is that option function return to normal display after 20 seconds.
Do not turn off the appliance before returning to the normal display mode.



Option setting function exists in the other items.
We will skip the explanation of the other functions by the option because it is associated with refrigerator control function and is not needed at SERVICE.
(Please do not set the other options except above SERVICE Manual.)

FUNCTION OFR FAILURE DIAGNOSIS

4-9) Option TABLE

1) Temperature changing table of freezer compartment

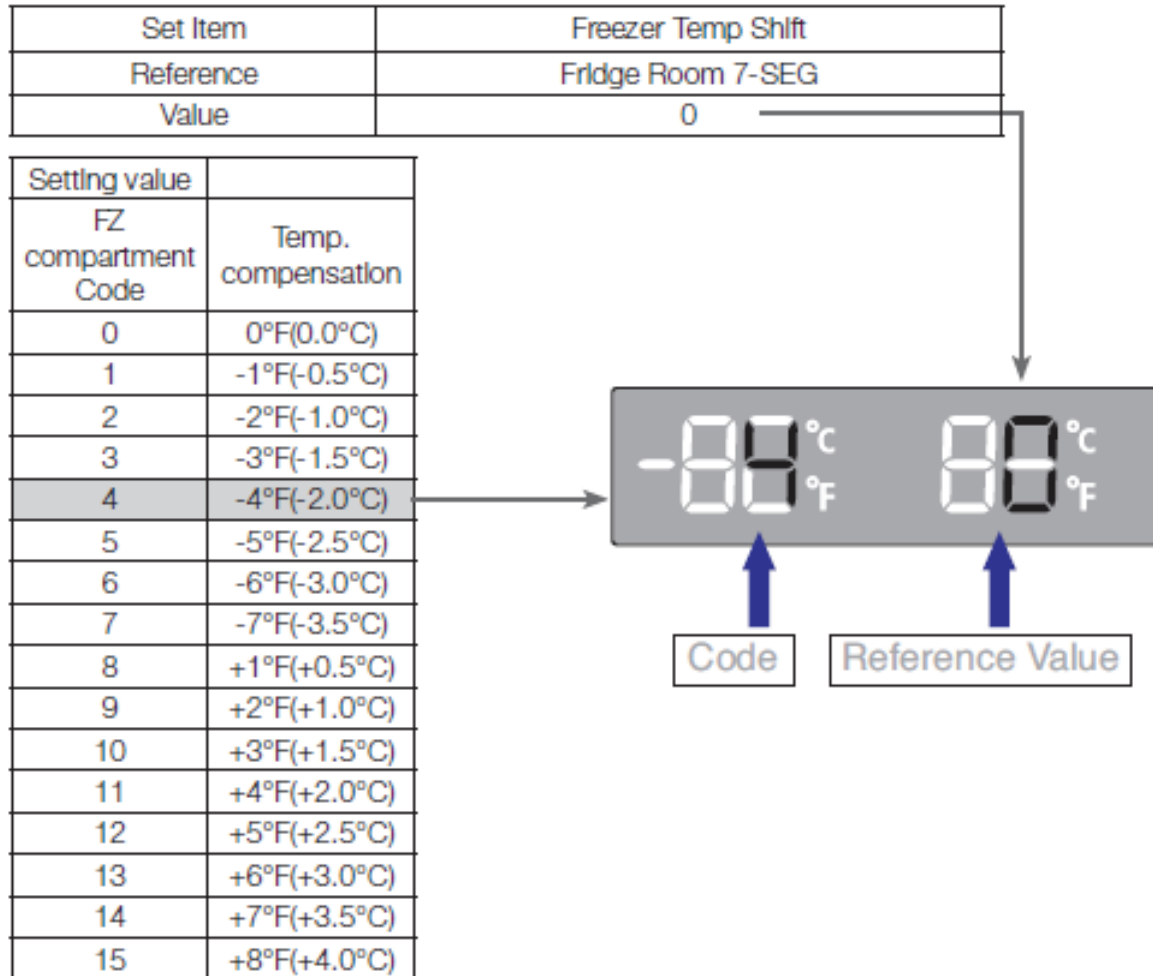

FUNCTION OFR FAILURE DIAGNOSIS

2) Temperature changing table of Fridge compartment

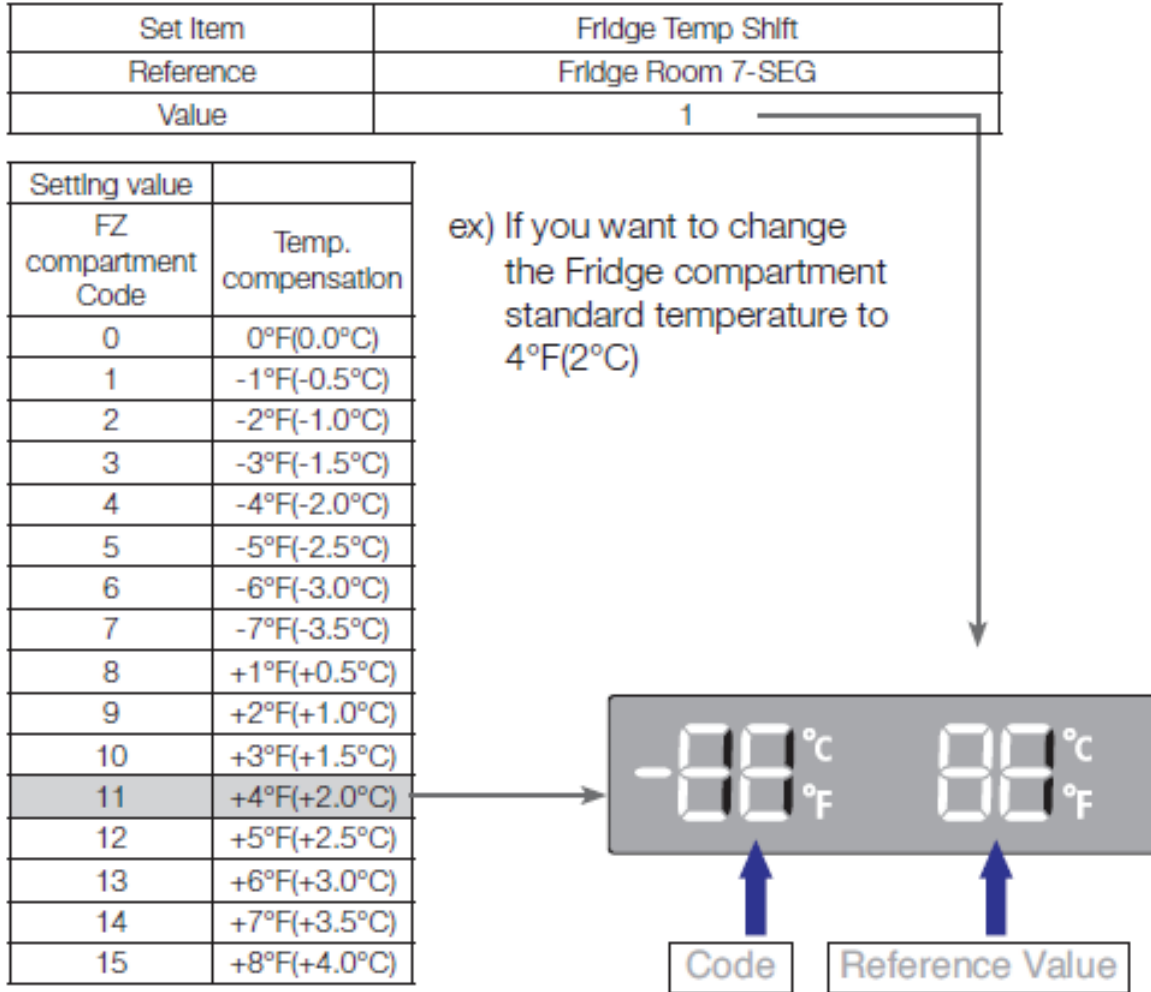

FUNCTION OFR FAILURE DIAGNOSIS

3) Ice Tray water supply of freezer compartment Ice Maker (In DISPENSER MODEL with flow sensor Only features)

Set Item	FZ-Room ICE TRAY
Reference	Fridge Room 7-SEG
Value	2

Setting value	
FZ compartment Code	Water Settings.
0	94cc
1	104cc

4) Eject waiting time changing table of freezer compartment Ice Maker (In DISPENSER MODEL Only features)

Set Item	FZ-Room Ice Maker Eject waiting time Shift
Reference	Fridge Room 7-SEG
Value	3

Setting value	
FZ compartment Code	Setting time
0	60min
1	47min
2	45min
3	53min
4	55min
5	57min
6	65min
7	70min
8	50min

FUNCTION OFR FAILURE DIAGNOSIS

5) Eject temperature changing table of freezer compartment Ice Maker (In DISPENSER MODEL Only features)

Set Item	FZ-Room Ice Maker Eject temperature Shift
Reference	Fridge Room 7-SEG
Value	4

Setting value	
FZ compartment Code	Temp. compensation
0	-7.5°C
1	-7.0°C
2	-6.5°C
3	-8.0°C
4	-8.5°C
5	-9.0°C
6	-9.5°C
7	-10.0°C

6) Minimum Comp RPM shifting

- This option is rising minimum Comp RPM.
As this option is applied, Comp operation.

Set Item	Minimum Comp RPM setting
Reference	Fridge Room 7-SEG
Value	12

Setting value	
FZ compartment Code	Comp RPM
0	No RPM Change
1	Minimum 2450RPM
2	Minimum 2450RPM
3	Minimum 2450RPM

FUNCTION OFR FAILURE DIAGNOSIS

7) Temp Display Option

- This option is for temp display all on mode.
If user wants temp display always on, this option is solution.

Set Item	Temp Display Option
Reference	Fridge Room 7-SEG
Value	16

Setting value	
FZ compartment Code	Temp Display Option
0	Normal Display (Temp display temporarily on at use)
1	Always Temp Display On
2	Always Temp Display On

8) Operation rate changing table of dispenser heater

Set Item	Dispenser Heater Rate
Reference	Fridge Room 7-SEG
Value	19

Setting value	
FZ compartment Code	Rate change
0	+0.0%
1	+ 20% operation (up to 100%)

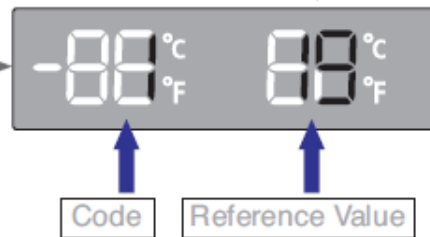

ex) If you want to change the dispenser heater operation rate to +20%

FUNCTION OFR FAILURE DIAGNOSIS

4-10) Diagnostic method according to the trouble symptom (Flow Chart)

DATA1.Temperature table

Resistance value and MICOM port voltage of sensor according to the temperature

SENSOR CHIP : based on PX41C, PX41C, 502AT/ 103**(ICE MAKER SENSOR(MOLD)/FULL UP, 20Kohm

(Actual measurement = value of the table below X 2)

°C	°F	Voltage	Resistance	°C	°F	Voltage	Resistance	°C	°F	Voltage	Resistance
-50	-58	4.694	153319	-5	23	3.107	16419	40	104	1.153	2997
-49	-56.2	4.677	144794	-4	24.8	3.057	15731	41	105.8	1.124	2899
-48	-54.4	4.659	136798	-3	26.6	3.006	15076	42	107.6	1.095	2805
-47	-52.6	4.641	129294	-2	28.4	2.955	14452	43	109.4	1.068	2714
-46	-50.8	4.622	122248	-1	30.2	2.904	13857	44	111.2	1.040	2627
-45	-49	4.602	115631	0	32	2.853	13290	45	113	1.014	2543
-44	-47.2	4.581	109413	1	33.8	2.802	12749	46	114.8	0.988	2462
-43	-45.4	4.560	103569	2	35.6	2.751	12233	47	116.6	0.963	2384
-42	-43.6	4.537	98073	3	37.4	2.700	11741	48	118.4	0.938	2309
-41	-41.8	4.514	92903	4	39.2	2.649	11271	49	120.2	0.914	2237
-40	-40	4.490	88037	5	41	2.599	10823	50	122	0.891	2167
-39	-38.2	4.465	83456	6	42.8	2.548	10395	51	123.8	0.868	2100
-38	-36.4	4.439	79142	7	44.6	2.498	9986	52	125.6	0.846	2036
-37	-34.6	4.412	75077	8	46.4	2.449	9596	53	127.4	0.824	1973
-36	-32.8	4.385	71246	9	48.2	2.399	9223	54	129.2	0.803	1913
-35	-31	4.356	67634	10	50	2.350	8867	55	131	0.783	1855
-34	-29.2	4.326	64227	11	51.8	2.301	8526	56	132.8	0.762	1799
-33	-27.4	4.296	61012	12	53.6	2.253	8200	57	134.6	0.743	1745
-32	-25.6	4.264	57977	13	55.4	2.205	7888	58	136.4	0.724	1693
-31	-23.8	4.232	55112	14	57.2	2.158	7590	59	138.2	0.706	1642
-30	-22	4.199	52406	15	59	2.111	7305	60	140	0.688	1594
-29	-20.2	4.165	49848	16	60.8	2.064	7032	61	141.8	0.670	1547
-28	-18.4	4.129	47431	17	62.6	2.019	6771	62	143.6	0.653	1502
-27	-16.6	4.093	45146	18	64.4	1.974	6521	63	145.4	0.636	1458
-26	-14.8	4.056	42984	19	66.2	1.929	6281	64	147.2	0.620	1416
-25	-13	4.018	40938	20	68	1.885	6052	65	149	0.604	1375
-24	-11.2	3.980	39002	21	69.8	1.842	5832	66	150.8	0.589	1335
-23	-9.4	3.940	37169	22	71.6	1.799	5621	67	152.6	0.574	1297
-22	-7.6	3.899	35433	23	73.4	1.757	5419	68	154.4	0.560	1260
-21	-5.8	3.858	33788	24	75.2	1.716	5225	69	156.2	0.546	1225
-20	-4	3.816	32230	25	77	1.675	5039	70	158	0.532	1190
-19	-2.2	3.773	30752	26	78.8	1.636	4861	71	159.8	0.519	1157
-18	-0.4	3.729	29350	27	80.6	1.596	4690	72	161.6	0.506	1125
-17	1.4	3.685	28021	28	82.4	1.558	4526	73	163.4	0.493	1093
-16	3.2	3.640	26760	29	84.2	1.520	4369	74	165.2	0.481	1063
-15	5	3.594	25562	30	86	1.483	4218	75	167	0.469	1034
-14	6.8	3.548	24425	31	87.8	1.447	4072	76	168.8	0.457	1006
-13	8.6	3.501	23345	32	89.6	1.412	3933	77	170.6	0.446	978
-12	10.4	3.453	22320	33	91.4	1.377	3799	78	172.4	0.435	952
-11	12.2	3.405	21345	34	93.2	1.343	3670	79	174.2	0.424	926
-10	14	3.356	20418	35	95	1.309	3547	80	176	0.414	902
-9	15.8	3.307	19537	36	96.8	1.277	3428	81	177.8	0.404	877
-8	17.6	3.258	18698	37	98.6	1.253	3344	82	179.6	0.394	854
-7	19.4	3.208	17901	38	100.4	1.213	3204	83	181.4	0.384	832
-6	21.2	3.158	17142	39	102.2	1.183	3098	84	183.2	0.375	810

FUNCTION OFR FAILURE DIAGNOSIS

DATA2. Humidity Sensor table

- Voltage output table @23°..., 5Vdc --- HTG3515CH/HTG3535CH

RH(Temperature compensate) = RH (Relative Humidity) + (Temp(°C) °c 23°C) x 0.05

RH(%)	Output (mV)	A/D (10 bit)	A/D (12 bit)	RH(%)	Output (mV)	A/D (10 bit)	A/D (12 bit)	RH(%)	Output (mV)	A/D (10 bit)	A/D (12 bit)
0	909	186	744	46	2246	460	1839	92	3452	706	2827
1	943	193	772	47	2272	465	1861	93	3478	712	2848
2	977	200	800	48	2298	470	1882	94	3504	717	2870
3	1010	207	827	49	2324	475	1903	95	3530	722	2891
4	1043	213	854	50	2350	481	1925	96	3566	730	2920
5	1076	220	881	51	2376	486	1946	97	3595	735	2944
6	1109	227	908	52	2402	491	1967	98	3624	741	2968
7	1141	233	935	53	2428	497	1989	99	3653	747	2992
8	1173	240	961	54	2454	502	2010	100	3683	754	3016
9	1205	247	987	55	2480	507	2031				
10	1235	253	1011	56	2505	513	2052				
11	1266	259	1037	57	2530	518	2072				
12	1297	265	1062	58	2555	523	2093				
13	1328	272	1088	59	2580	528	2113				
14	1359	278	1113	60	2605	533	2133				
15	1390	284	1138	61	2630	538	2154				
16	1420	291	1163	62	2655	543	2174				
17	1450	297	1188	63	2680	548	2195				
18	1480	303	1212	64	2705	553	2215				
19	1510	309	1237	65	2730	559	2236				
20	1540	315	1261	66	2756	564	2257				
21	1569	321	1285	67	2782	569	2278				
22	1598	327	1309	68	2808	575	2300				
23	1627	333	1333	69	2834	580	2321				
24	1656	339	1356	70	2860	585	2342				
25	1685	345	1380	71	2886	590	2364				
26	1713	350	1403	72	2912	596	2385				
27	1741	356	1426	73	2938	601	2406				
28	1769	362	1449	74	2964	606	2428				
29	1797	368	1472	75	2990	612	2449				
30	1825	373	1495	76	3017	617	2471				
31	1852	379	1517	77	3044	623	2493				
32	1879	384	1539	78	3071	628	2515				
33	1906	390	1561	79	3098	634	2537				
34	1933	395	1583	80	3125	639	2559				
35	1960	401	1605	81	3152	645	2581				
36	1986	406	1627	82	3179	650	2604				
37	2012	412	1648	83	3206	656	2626				
38	2038	417	1669	84	3233	661	2648				
39	2064	422	1690	85	3260	667	2670				
40	2090	428	1712	86	3288	673	2693				
41	2116	433	1733	87	3316	678	2716				
42	2142	438	1754	88	3344	684	2739				
43	2168	444	1776	89	3372	690	2762				
44	2194	449	1797	90	3400	696	2785				
45	2220	454	1818	91	3426	701	2806				

5. DISASSEMBLY AND REASSEMBLY

5-1) CCase Output Terminal

(The Main PCB and the Case Output Terminals are connected with wire connectors.)

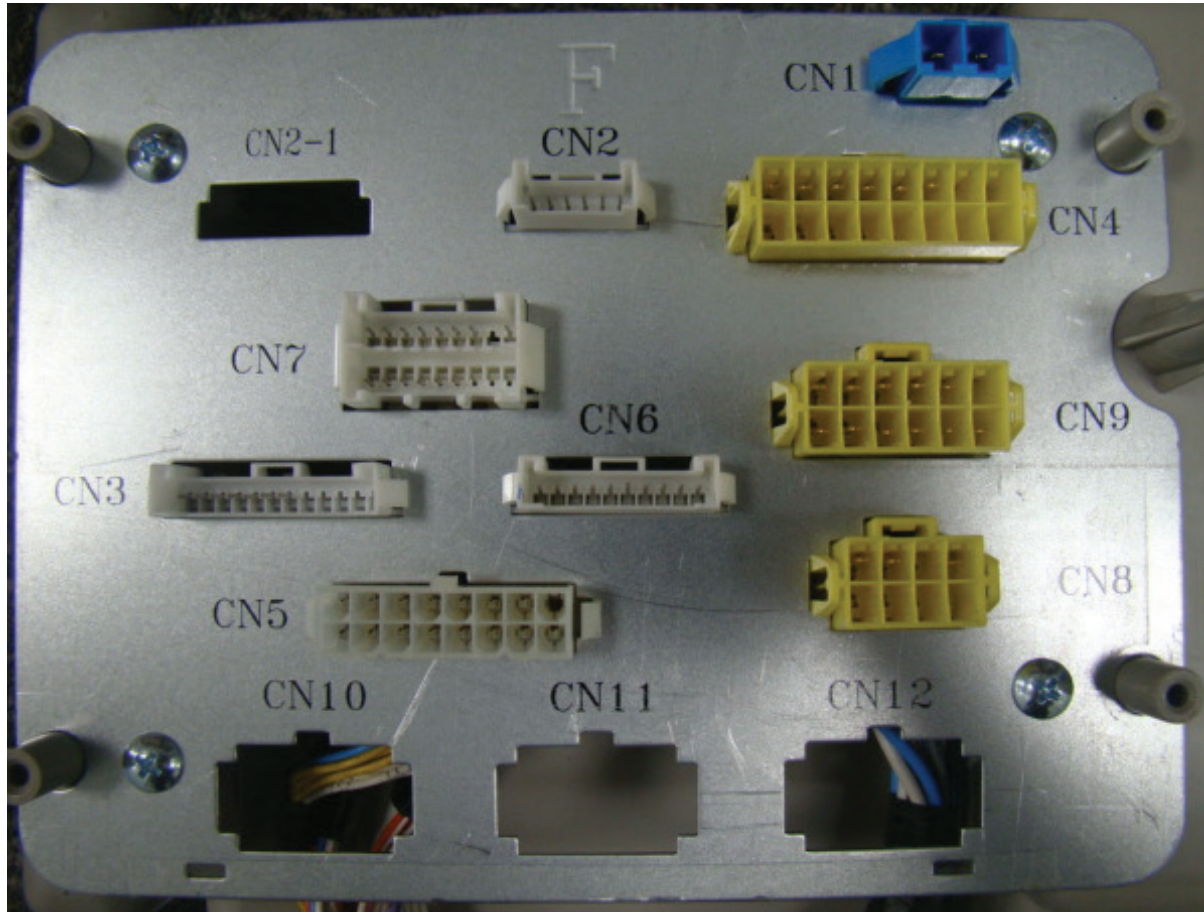

*Test the terminals on the PCB Case to check for voltage or operation related errors concerning QUEEN PJT. The terminal composition is shown in the diagram. If an error is found while testing the above terminals and the housing connectors, check the inside of the PCB Case.
=> The following descriptions are based on the PCB Case.

DISASSEMBLY AND REASSEMBLY

[TBI-UPGRADE]PLATE FIXER HOUSING PIN MAPPING (GRAY COLOR : OPTIONAL SPEC)

CN NAME	CN2-1	CN2	CN7	CN3	CN6	CN5	CN1	CN4	CN9	CN8
AC/DC Housing Pin Q'ty	DC	DC	DC	DC	DC	DC	AC	AC	AC	AC
	X	6	18	12	10	16	2	16	12	8
#1	-	GND (F FAN, F S/S)	STEP VALVE (12V)	R SENSOR	I/M MOTOR (CCW)	DISPLAY RX [SET TX]	POWER (LIVE)	AUGER & CUBE MOTOR [L]	LIVE JOINT (F/R DOOR C-ROOM)	R DEF H/T [L] SUB H/T [L]
#2	-	F FAN VCC	STEP VALVE (A PHASE)	R DEF SENSOR	I/M MOTOR (CW)	DISPLAY RX [SET RX]	POWER (NEUTRAL)	CUBE MOTOR [N]	COMP OLP	R DEF H/T [N] SUB H/T [N]
#3	-	F FAN FG	STEP VALVE (A' PHASE)	GND (R FAN, R, S/S)	I/M SENSOR	DISPLAY 12V	-	AUGER MOTOR [N]	COMP OLP	-
#4	-	CUBE M/T SWITCH	STEP VALVE (B PHASE)	R FAN VCC	IM TEST SWITCH	DISPLAY 5V	-	ICE MAKER HEATER [N]	ICE VALVE [N]	WATER PIPE HEATER [N]
#5	-	F SENSOR	STEP VALVE (B' PHASE)	R FAN FG	I/M FULL SWITCH	GND IF DOOR DISPLAY, F DOOR S/S & S/W	-	F DEF H/T [N] SUB H/T [N]	DISP HEATER [N]	
#6	-		F DOOR SWITCH	R LAMP VCC	I/M HOR SWITCH	-	-	F DEF H/T [L] SUB H/T [L]	-	
#7	-		R DOOR SWITCH	R LAMP GND	I/M GND	EXT SENSOR (F DOOR)	-	-	ICE ROUTE MOTOR [N]	
#8	-		(HOME-BAR SWITCH)	-	I/M 12V	LEVER SWITCH	-	-	WATER VALVE [N]	
#9	-		GND (DOOR, H-BAR S/W)	-	F LAMP VCC	-	-	-	AUGER MOTOR SWITCH [L]	
#10	-		C FAN GND	-	F LAMP GND	ICE ROUTE SWITCH 1	-	-	INV COMP [U PHASE]	
#11	-		C FAN VCC	-	-	ICE ROUTE SWITCH 2	-	-	INV COMP [V PHASE]	
#12	-		C FAN FG	-	-	WIFI MODULE TX [SET RX]	-	-	INV COMP [W PHASE]	
#13	-		HUMIDITY S/S GND	-	-	WIFI MODULE GND	-	-	-	
#14	-		HUMIDITY S/S VCC	-	-	WIFI MODULE RX [SET TX]	-	-	-	
#15	-		HUMIDITY S/S SIGNAL	-	-	WIFI MODULE RESET	-	-	-	
#16	-		(FLOW S/S SIG OUT)	-	-	WIFI MODULE 12V	-	-	-	
#17	-		(FLOW S/S GND)	-	-	-	-	-	-	
#18	-		(FLOW S/S VCC)	-	-	-	-	-	-	

Pin
Function

DISASSEMBLY AND REASSEMBLY

5-2) How to Enter the Test Mode

1) When there is no Power (SMPS PCB)

CAUTION There are AC input voltage running on CN1. So, be cautious when repairing the unit or measuring values.

SMPS PCB CHECK Using Multimeter

- ☞ Where to Check Input Voltage AC Voltage at CN1
- ☞ Where to Check DC 12V At both CN5 ③ → CN2①
- ☞ Where to Check DC 5V At both CN5 ④ → CN2①

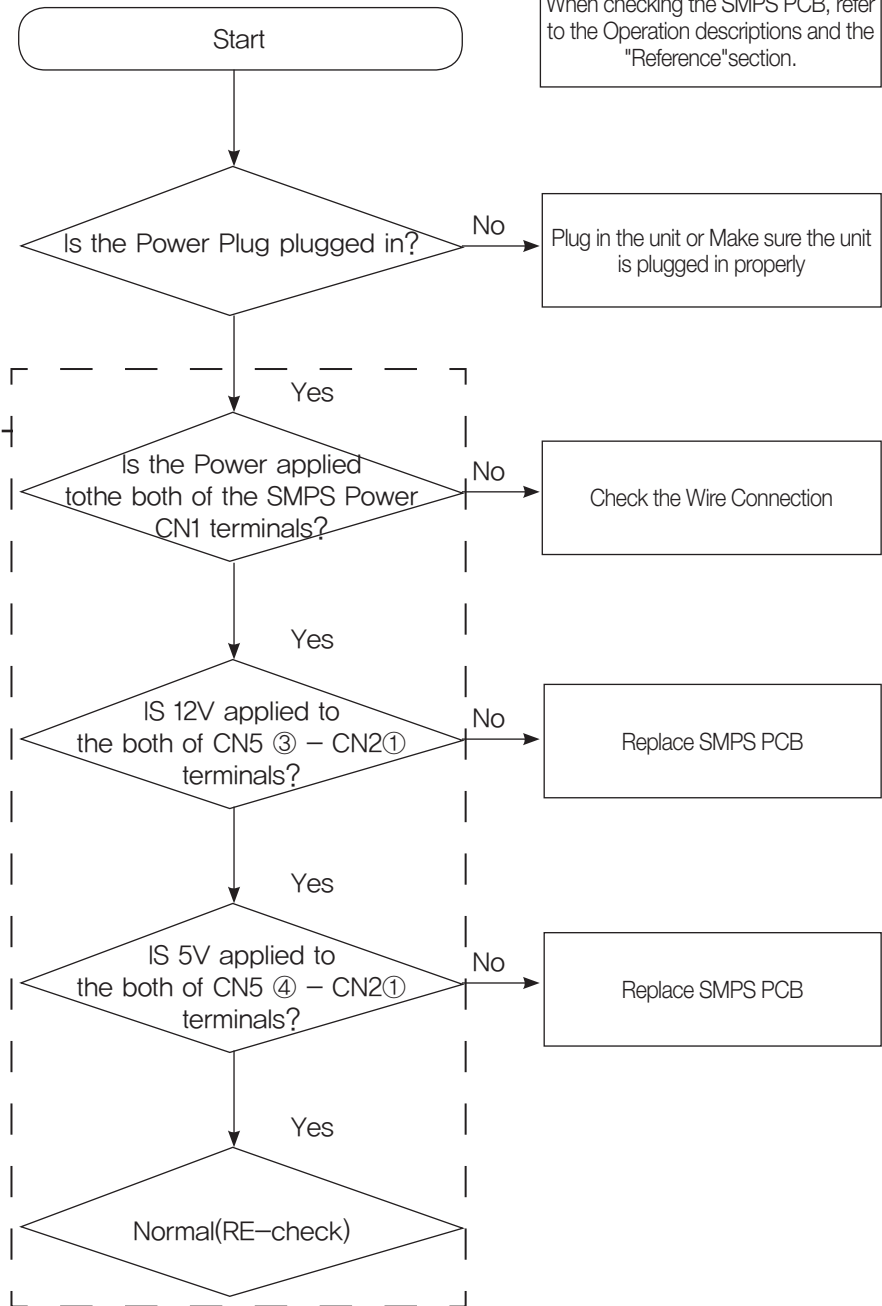
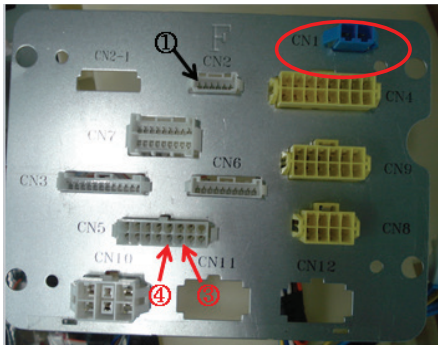

DISASSEMBLY AND REASSEMBLY

2) When the compressor does not operate (Inverter Comp)

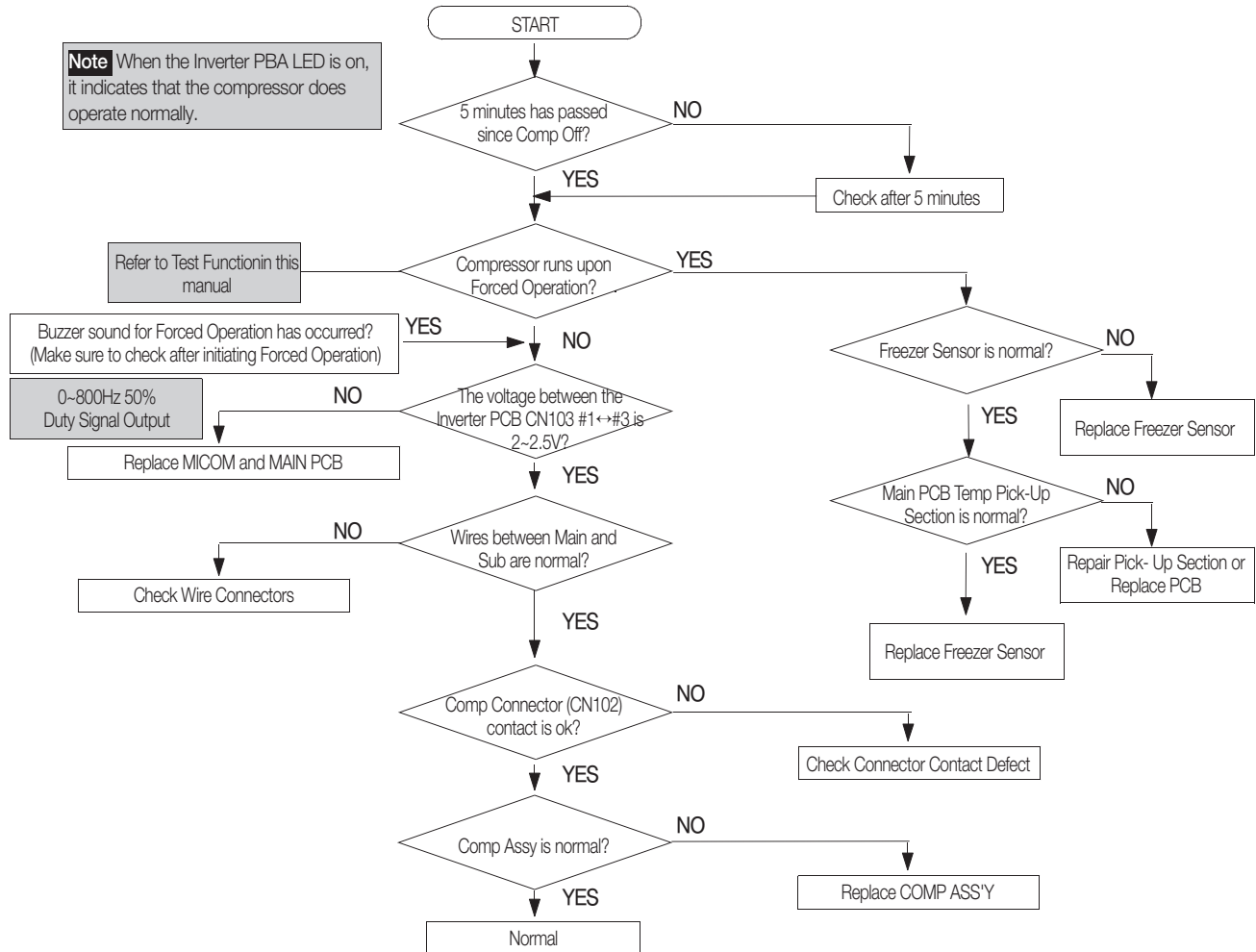





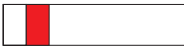

DISASSEMBLY AND REASSEMBLY

3) Troubleshooting based on LED Blinking Frequency

When failure is detected by the Inverter PCB, the Compressor will immediately stop if the Compressor is running and there will be a 5 minute standby. During the 5 minute standby, RPM signals will be ignored.

That is, even though the Inverter PCB receives the RPM signals, the Compressor does not work. It blinks every second and there is 2 second off at the end of each cycle.

LED Blinking Frequency	Protecting Functions	Remarks
	Normal Operation	N/A
	Starting Failure	1. Check the COMP terminals short(U,V,W) 2. Check IPM Pins short of Inverter PBA
	IPM Fault	3. Check IPM operating Voltage(under DC 13.5V) 4. Other cases, check the COMP, cycle, etc.
	Abnormal Current Detection	1. Check COMP wire connections(U,V,W) 2. Check PCB Bottom side soldering state 3. Other cases, check the COMP, cycle, etc.
	Motor Locked / Over RPM	1. Check PCB Bottom side soldering state. 2. Check Input voltage oscillation 3. Other cases, check the COMP, cycle, etc.
	Under Voltage	1. Check input voltage under AC 53V(Input Power AC110 ~ 127V) or AC 106V(Input Power AC220 ~ 240V) 2. Check PCB Bottom side soldering sate.
	Over Voltage	1. Check input voltage over AC 155V(Input Power AC110 ~ 127V) or AC 310V(Input Power AC220 ~ 240V) 2. Check PCB Bottom side soldering sate.

DISASSEMBLY AND REASSEMBLY

4) When Defrost does not work

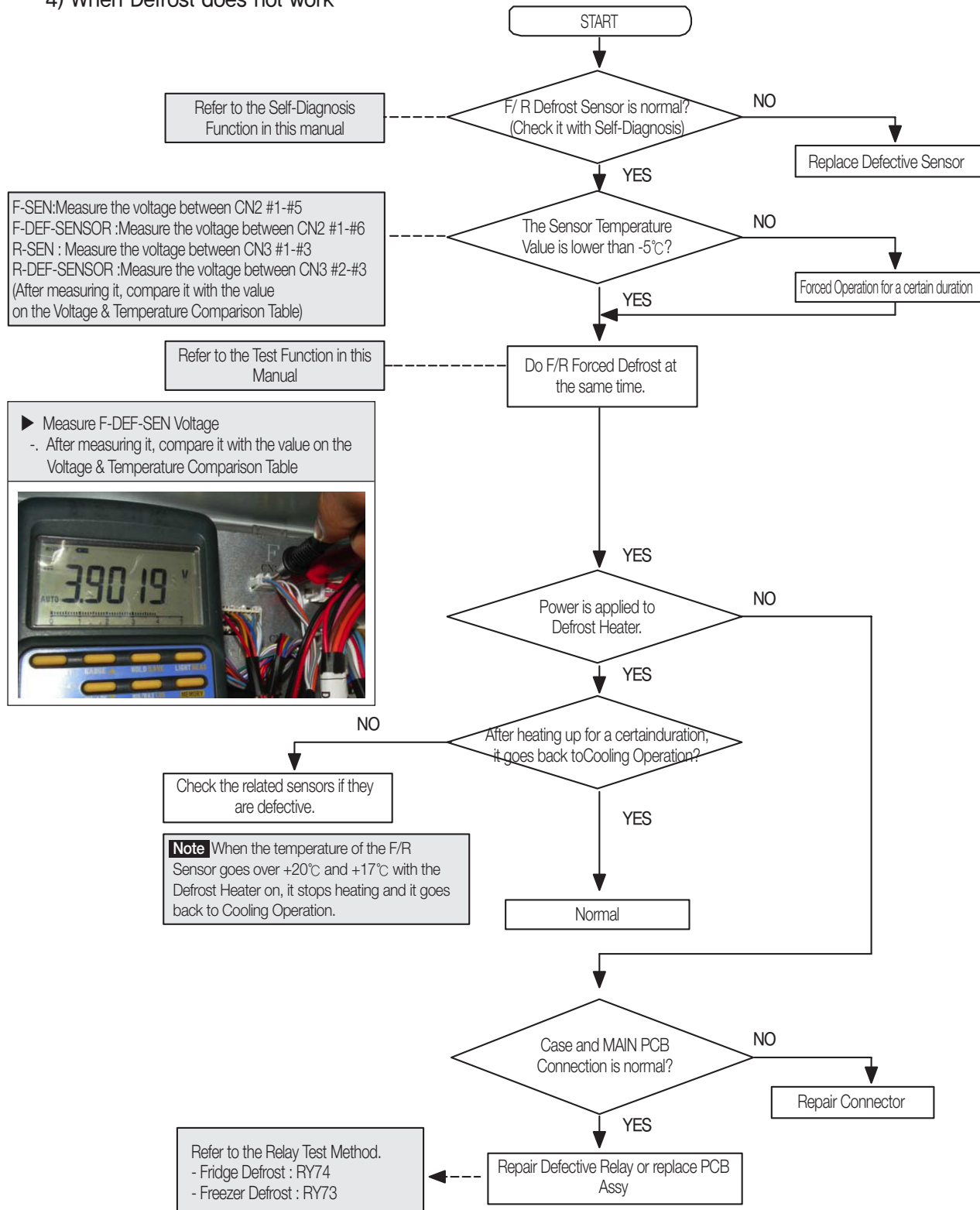

DISASSEMBLY AND REASSEMBLY

5) When there is Self-Diagnosis Error (with Defective Sensor)

- The error of sensor will be displayed on the front of display. when the error of sensor is detected at initial power ON, the appliance will not operated and the error message will be displayed.
- The appliance will not stop operating when the error of sensor is detected during operation of the appliance. But normal freezing might be not operated if the appliance is operated by the emergency operation mode. You would better to check the appliance according to the self-diagnosis of the manual.

- ① When R-Room Sensor error occurs (check the other sensors in the same procedure)
 -. Measure with PCB Case as a base

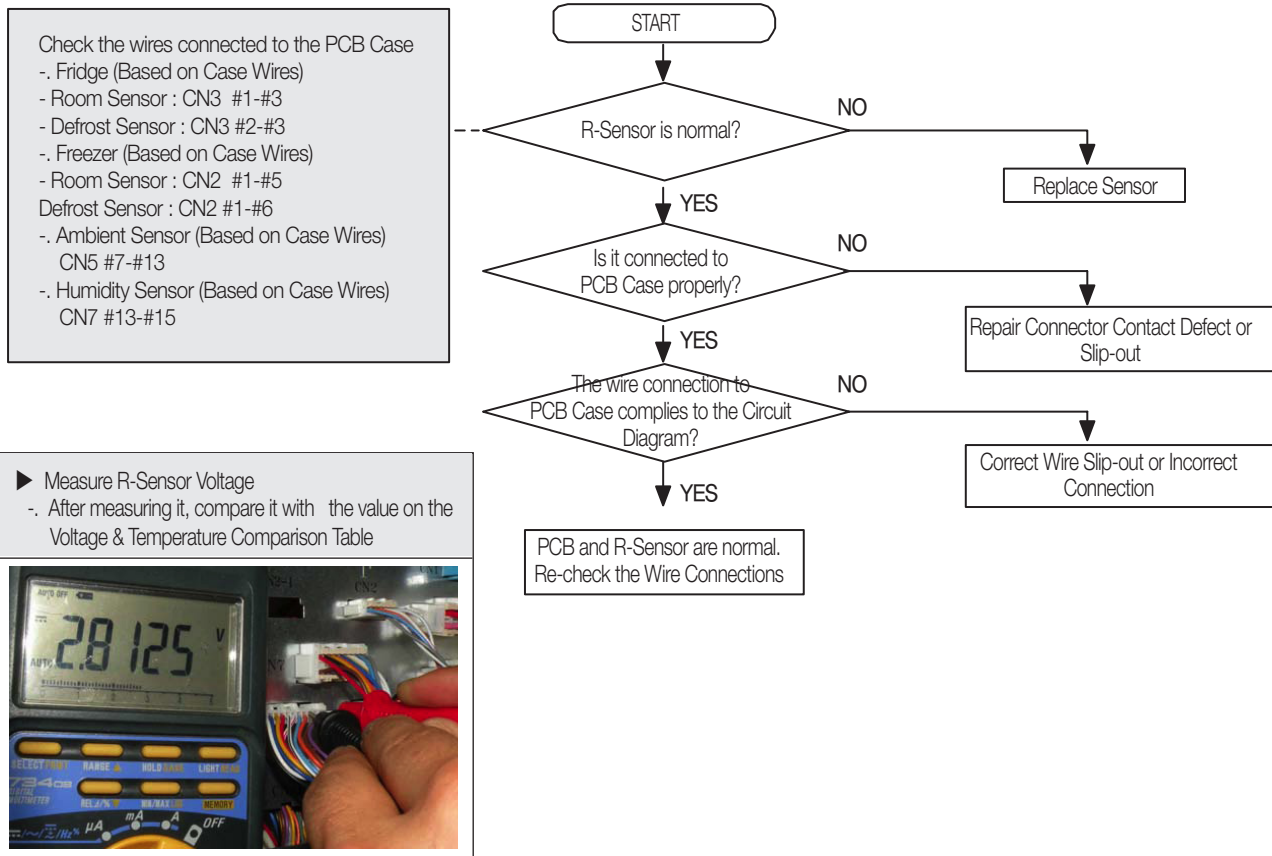

DISASSEMBLY AND REASSEMBLY

6) When the alarm sound will not turn off.

① When Door Open "Sound" keeps alarming

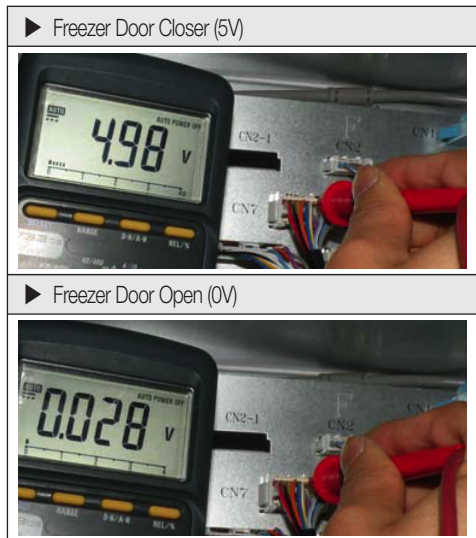

Freezer Door CN7 ⑥-⑬
Fridge Door CN7 ⑦-⑬
- Normal Voltage : Open 0V & Close 5V

When measuring the resistance of the Door S/W, check if it shifts $0\Omega \leftrightarrow \infty\Omega$ as turning on and off the Door S/W.

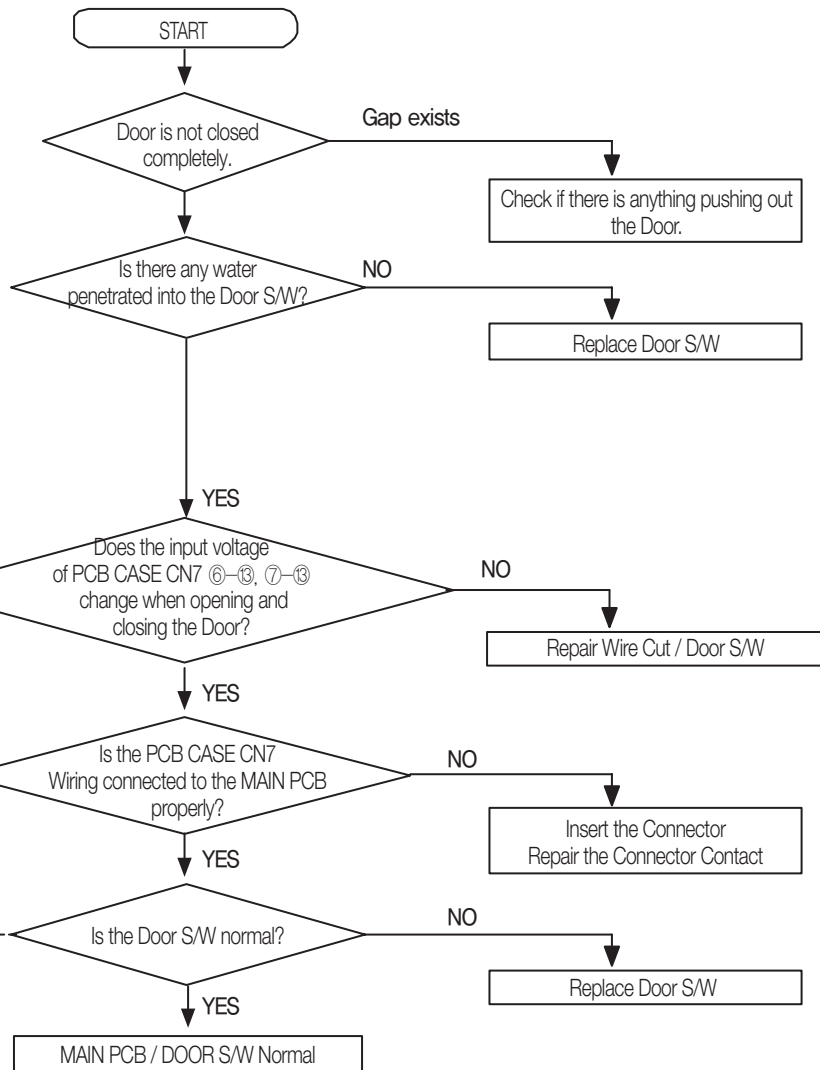

② When alarm sound "Beep" continues

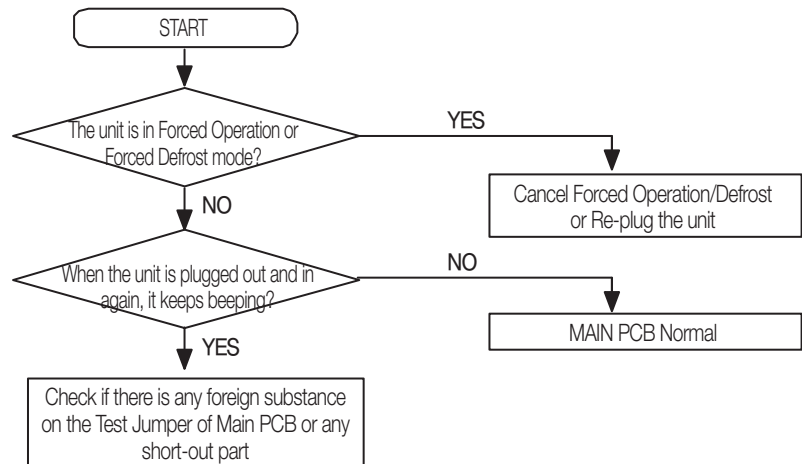

DISASSEMBLY AND REASSEMBLY

7) When the Display is defective or there is Communication Error

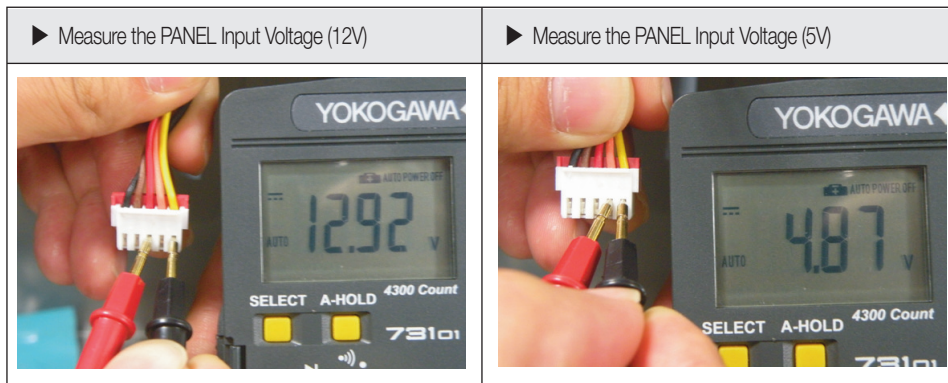
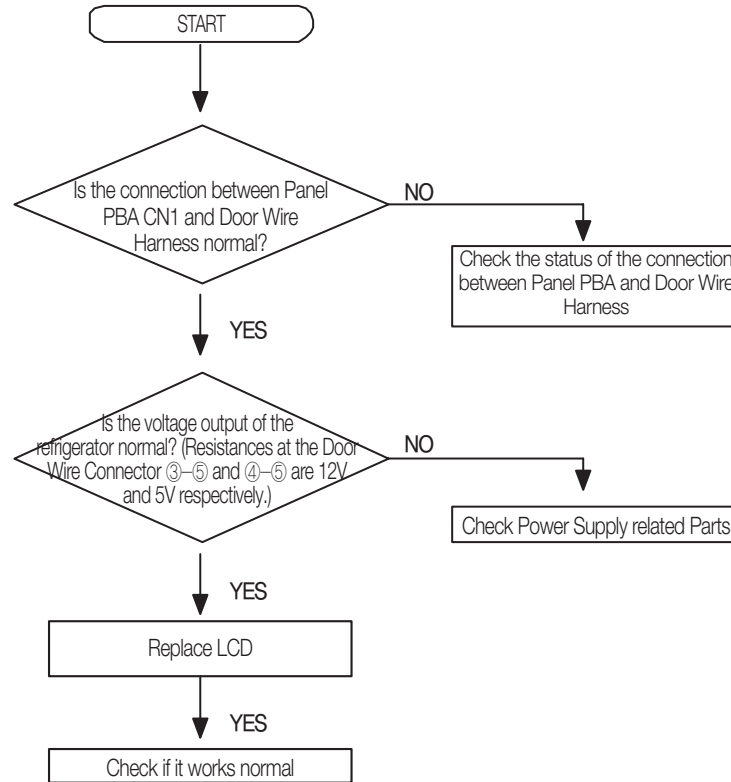

DISASSEMBLY AND REASSEMBLY

8) When Fan does not operate

- This refrigerator uses the BLDC Fan Motor. The BLDC Motor operates with DC 7~12V.
- Under Comp On conditions, the F-Fan operates generally. But, the F-Fan Motor may not work due to various conditions (such as the operating condition of Cool Select Pantry, etc) ,and when the ambient temperature is high or when you open and close the Door once, it operates after one minute delay. So, don't get misled by it. It is normal.
- Also, when the Fridge Door is open, the Freezer Fan Motor stops together with the Fridge Fan Motor (for the purpose of performance improvement).

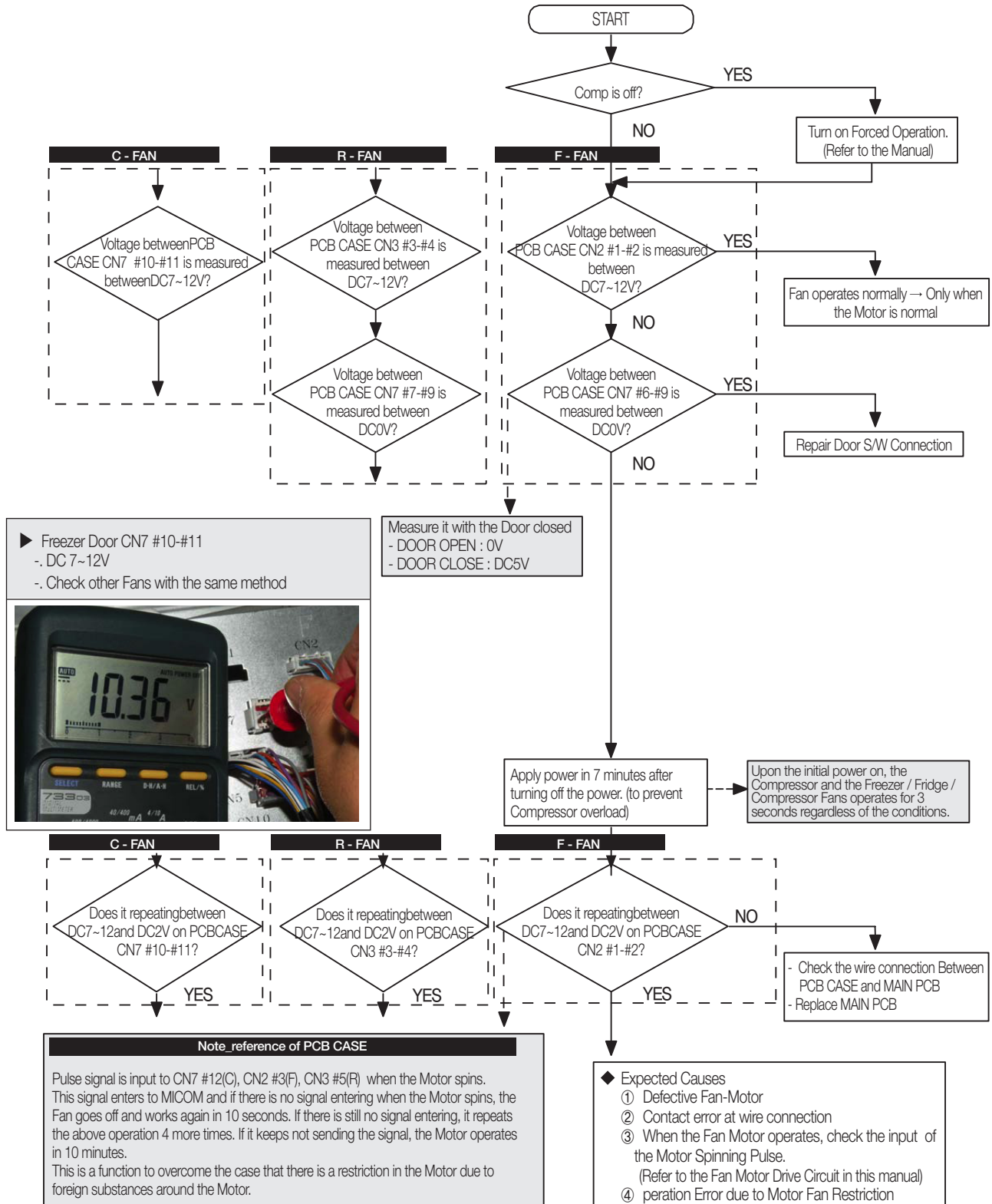

DISASSEMBLY AND REASSEMBLY

9) When the Freezer / Fridge Lamp does not light up

CAUTION

1. When replacing the Freezer Lamp, be sure to turn off the power to prevent electric shock.
2. LED lamps are used in the both of the Fridge and the Freezer compartments of this model.

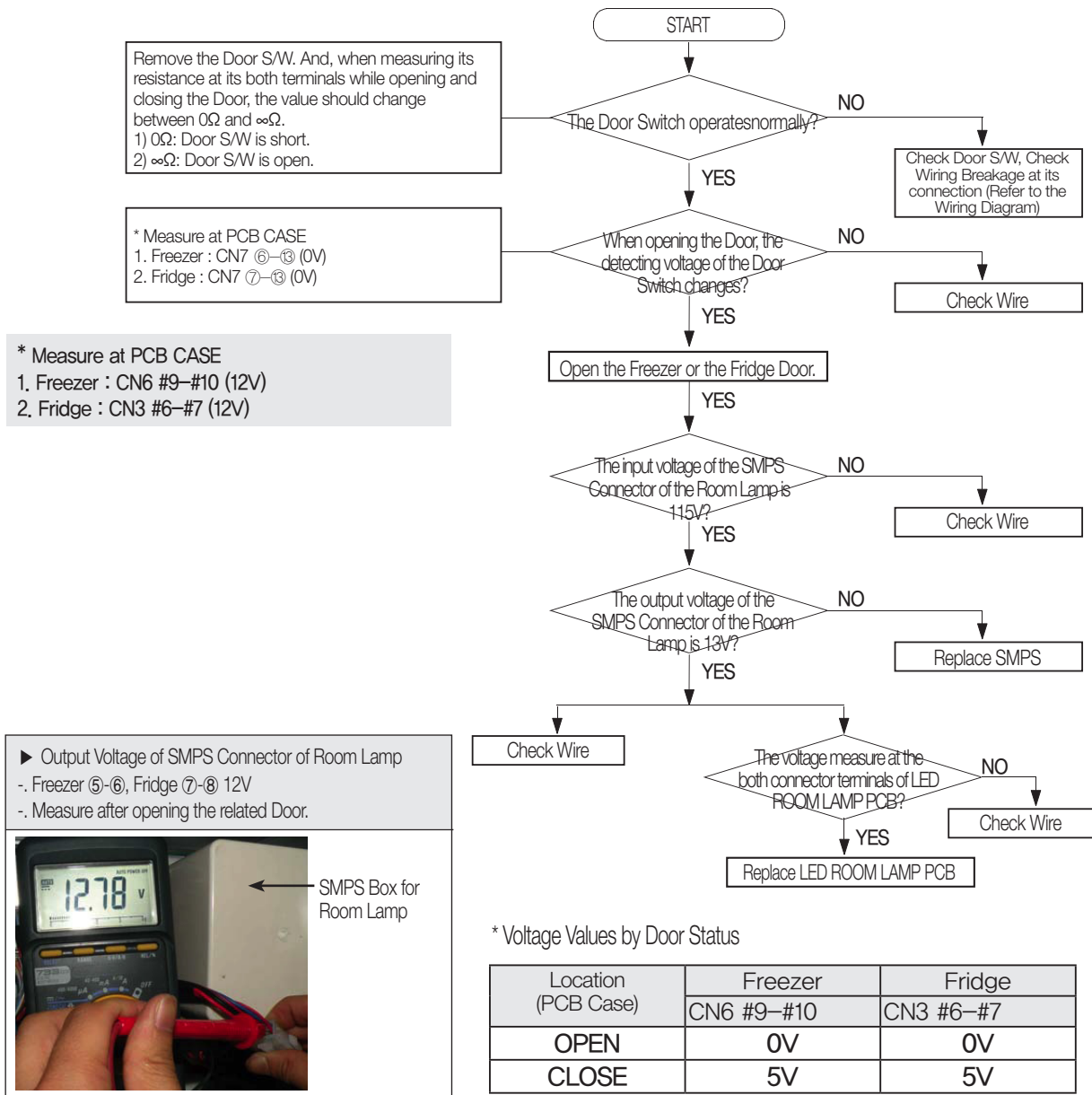

DISASSEMBLY AND REASSEMBLY

10) When there is problem in the sound function

〈Caution〉 The Panel PBA Power Terminals are sensitive to static electricity. So, please take care while repairing or measuring values.

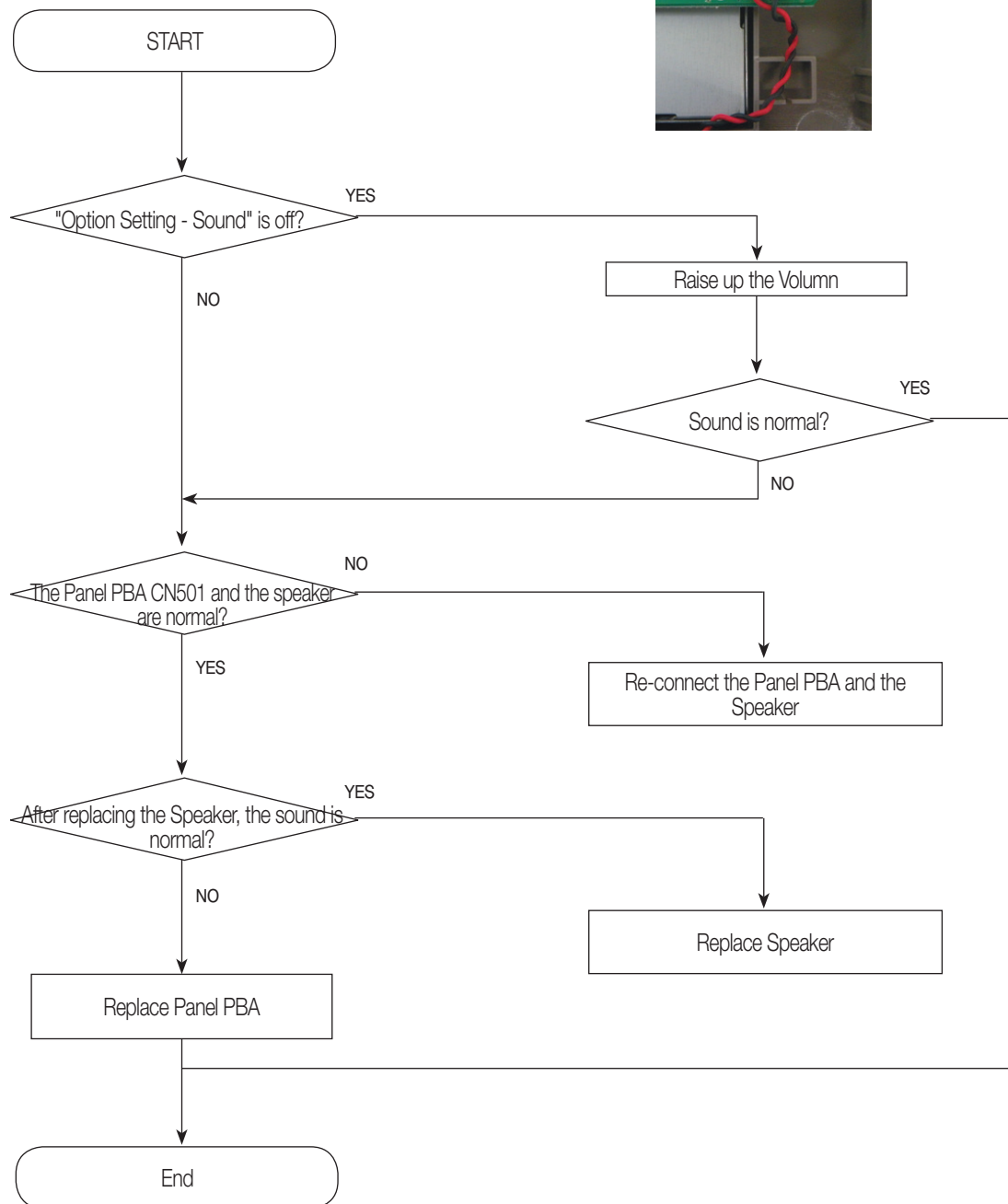
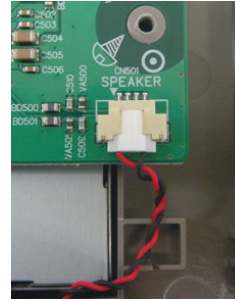

DISASSEMBLY AND REASSEMBLY

11) When the Cover Ice Route Motor (Geared Motor) does not work properly

CAUTION

1. When replacing the Cover Ice Motor, pull out the plug to avoid an electric shock.
2. Be careful! When disassemble the Cover Ice Motor, spring can jumped out and may cause personal injury.
3. Motor will rotate continuously when the Motor Switch is not sensed.

① When the Cover Ice Motor does not operate

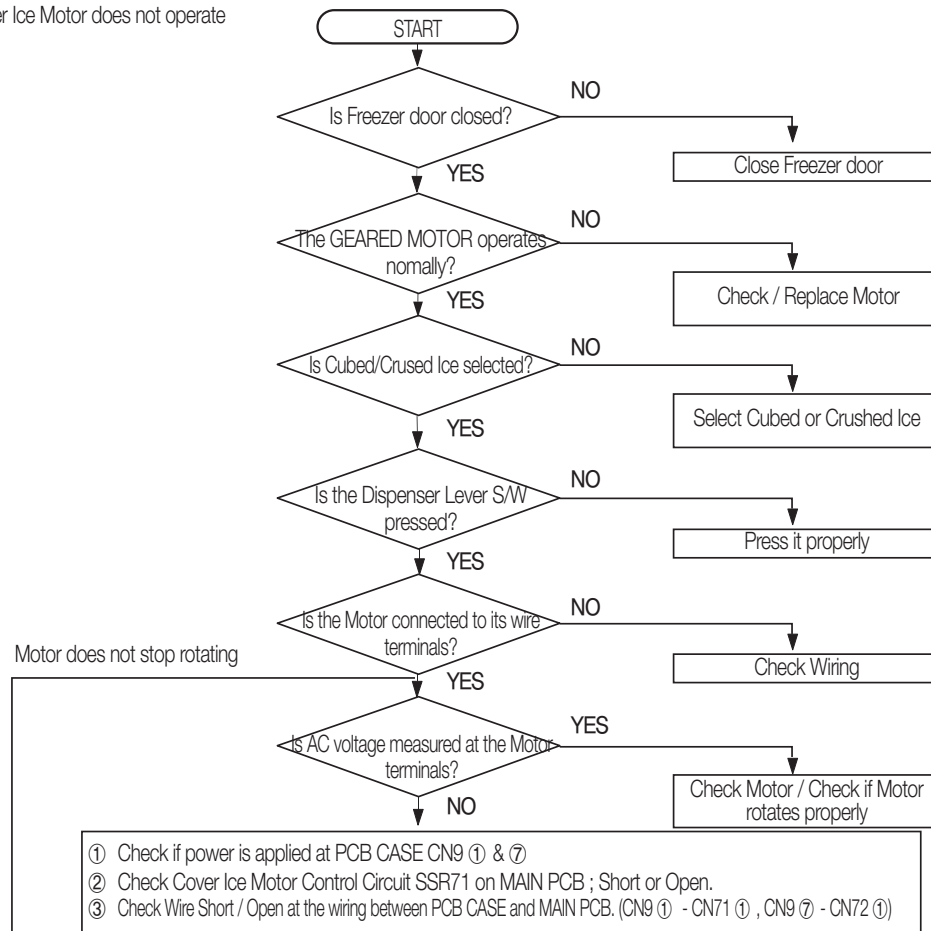

- ① Check if power is applied at PCB CASE CN9 ① & ⑦
- ② Check Cover Ice Motor Control Circuit SSR71 on MAIN PCB ; Short or Open.
- ③ Check Wire Short / Open at the wiring between PCB CASE and MAIN PCB. (CN9 ① - CN71 ① , CN9 ⑦ - CN72 ①)

← ② When the Cover Ice Motor does not stop rotating
 ※ When it is still defective with the above corrective actions

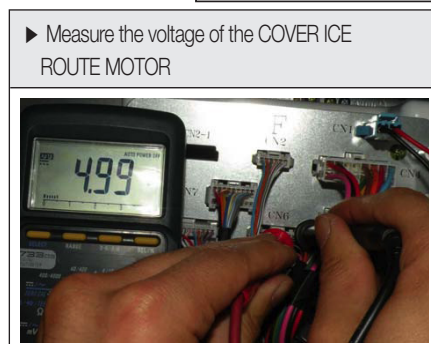

When facing the Display Panel,
 Left:S/W1 and Right : S/W2
 When opening the Cover
 S/W1 is pressed : 0V, S/W2 : 5V
 When closing the Cover S/W1, S/W2 is pressed : 0V

- ① Check Wire Open / Short at CASE PCB WIRE - COVER ICE MOTOR Rotation Pick-Up Switch
- ② Check Cover Ice Motor Control Circuit SSR71 on MAIN PCB ; Short or Open
- ③ Check Wire Short / Open at the wiring between PCB CASE and MAIN PCB. (CN9 ① - CN71 ① , CN9 ⑦ - CN72 ①)
- ④ Replace MAIN PCB or the entire PCB CASE

DISASSEMBLY AND REASSEMBLY

12) When the Water Valve does not work

Pre-checking

1. Water is directly supplied to the Water Valve. So, make sure to cut off the water before doing repairs.
2. There is electricity flowing in the wire. So, take extra care not to get electric shock.

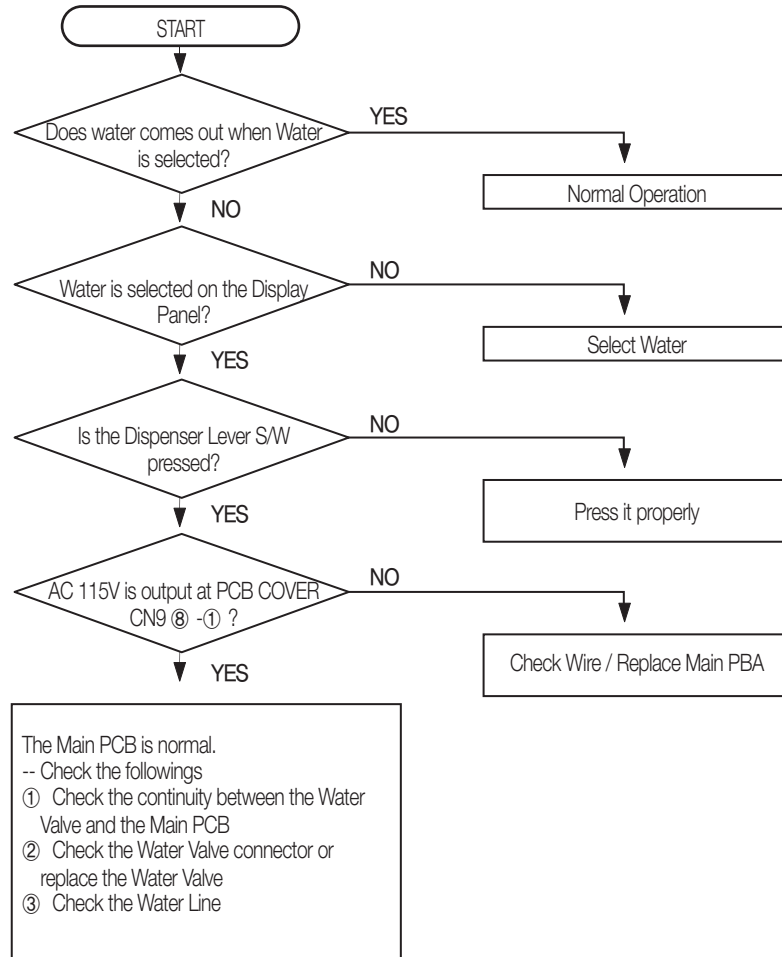

DISASSEMBLY AND REASSEMBLY

13) When the Crushed / Cube ICE has trouble

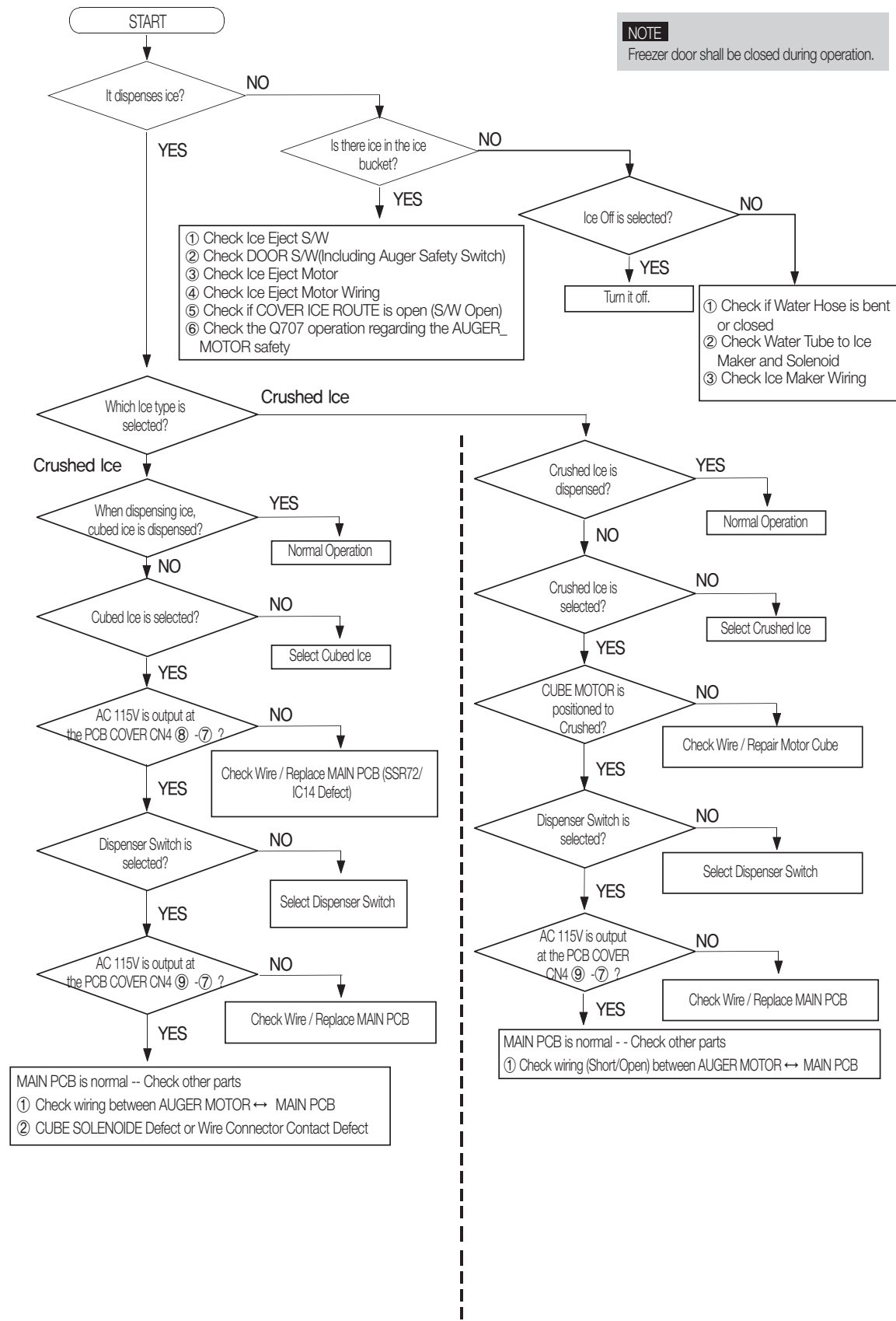

6. PCB DIAGRAM

6-1) PBA Layout with part position.....	94
5-2) Connector Layout & Descriptions of Inverter Controller Board	95
5-3) Connector Layout with part position (Main Board)	96
5-4) Connector Layout with part position (Inverter PBA, SMPS PBA)	97

PCB DIAGRAM

6-1) PBA Layout with part position

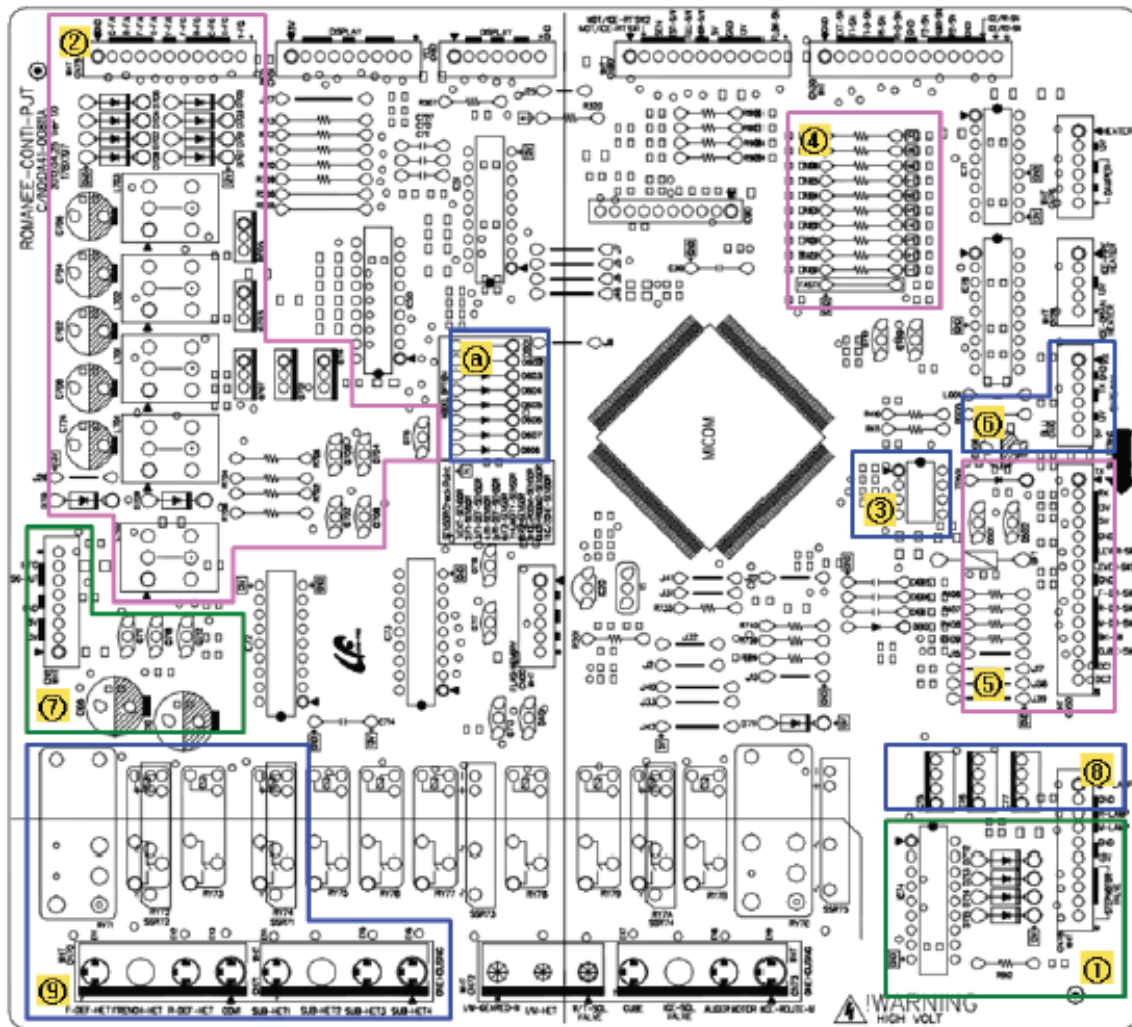

1. Step-Valve Controlling Circuit (TDM Cycle)
 2. Fan Motor Driving Circuit
 - It supplies to various types of motors(7~12V)
 3. EEPROM : It stores various types of data
 4. By receiving various sensor signals, it sends them to MICOM after removing noise
 5. PBA Panel Communication and Power Supply Circuit
 6. Power Line Communication Circuit (PLC input / output)
 7. Inverter Compressor Driving Signal Section
 8. LED Lamp Controlling
 9. AC Load Controlling (Driver IC, Relay, AC Connector)
- a. Diode Option Setting Section

PCB DIAGRAM

6-2) Connector Layout & Descriptions of Inverter Controller Board

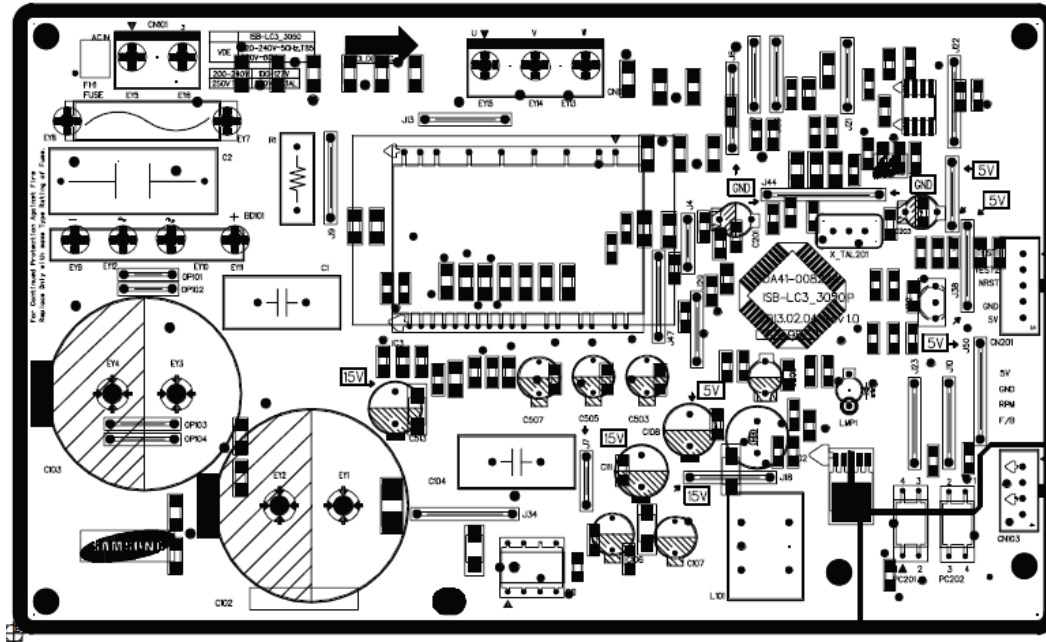

- PCB Power Supply : From the AC Input Voltage(115V), it supplies DC 15V and 5V to the Inverter circuit for the Compressor control.
- COMP Driving / Feedback Circuit It receives the COMP operation signals from the Main PBA and feedbacks the inverter errors to the Main PBA.
- Micom (MN103SFC2D)
- BOOTSTRAP Charger : It is an independent power circuit for the driving of the IMP High-Phase IGBT.
- Current Pickup Circuit : It pickups the currents taken by the Shunt resistance and does the PWM DUTY control.
- IPM (FNB40560)
- Micom (MN103SFC2D)

PCB DIAGRAM

6-3) Connector Layout with part position (Main Board)

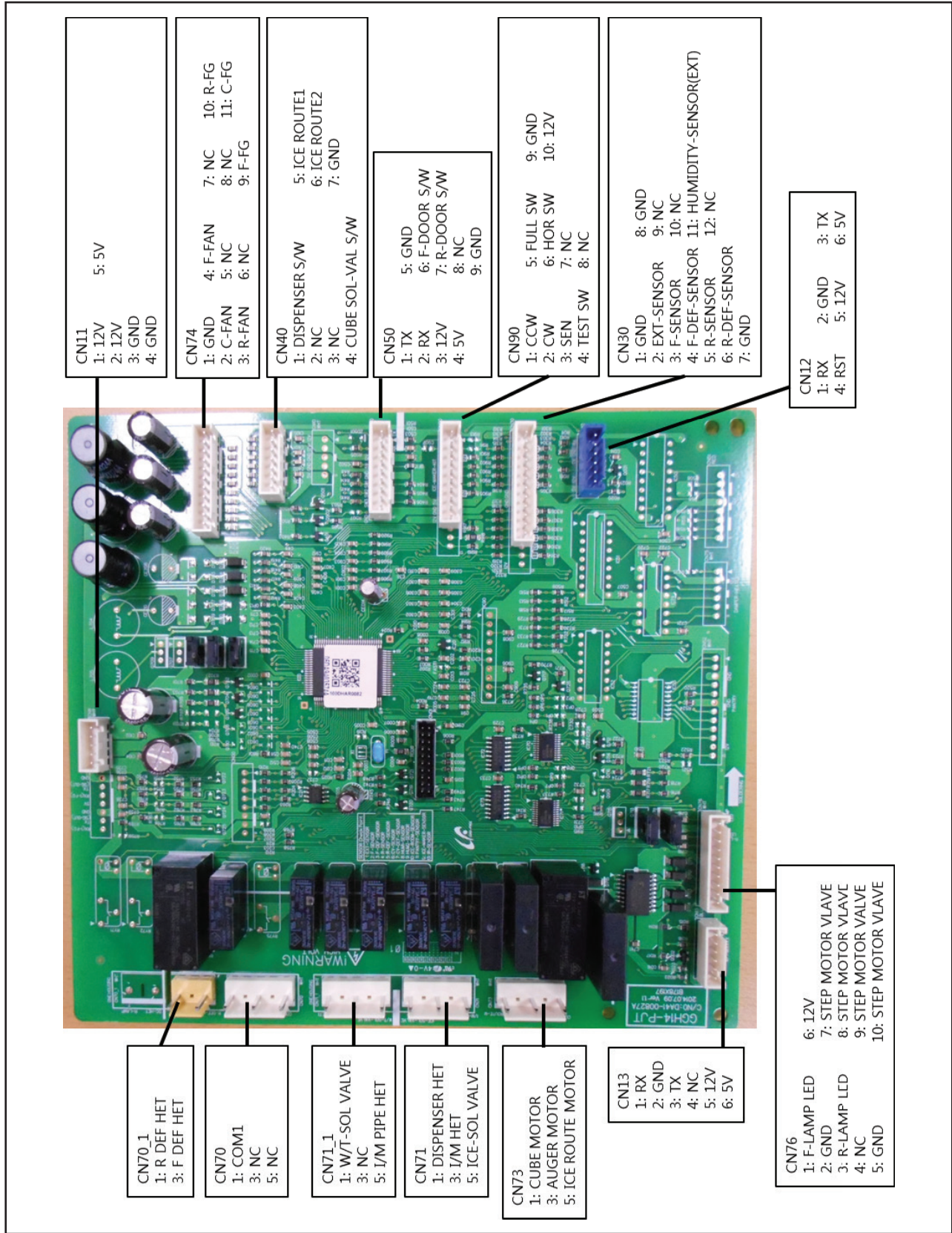

PCB DIAGRAM

6-4) Connector Layout with part position (Inverter PBA, SMPS PBA)

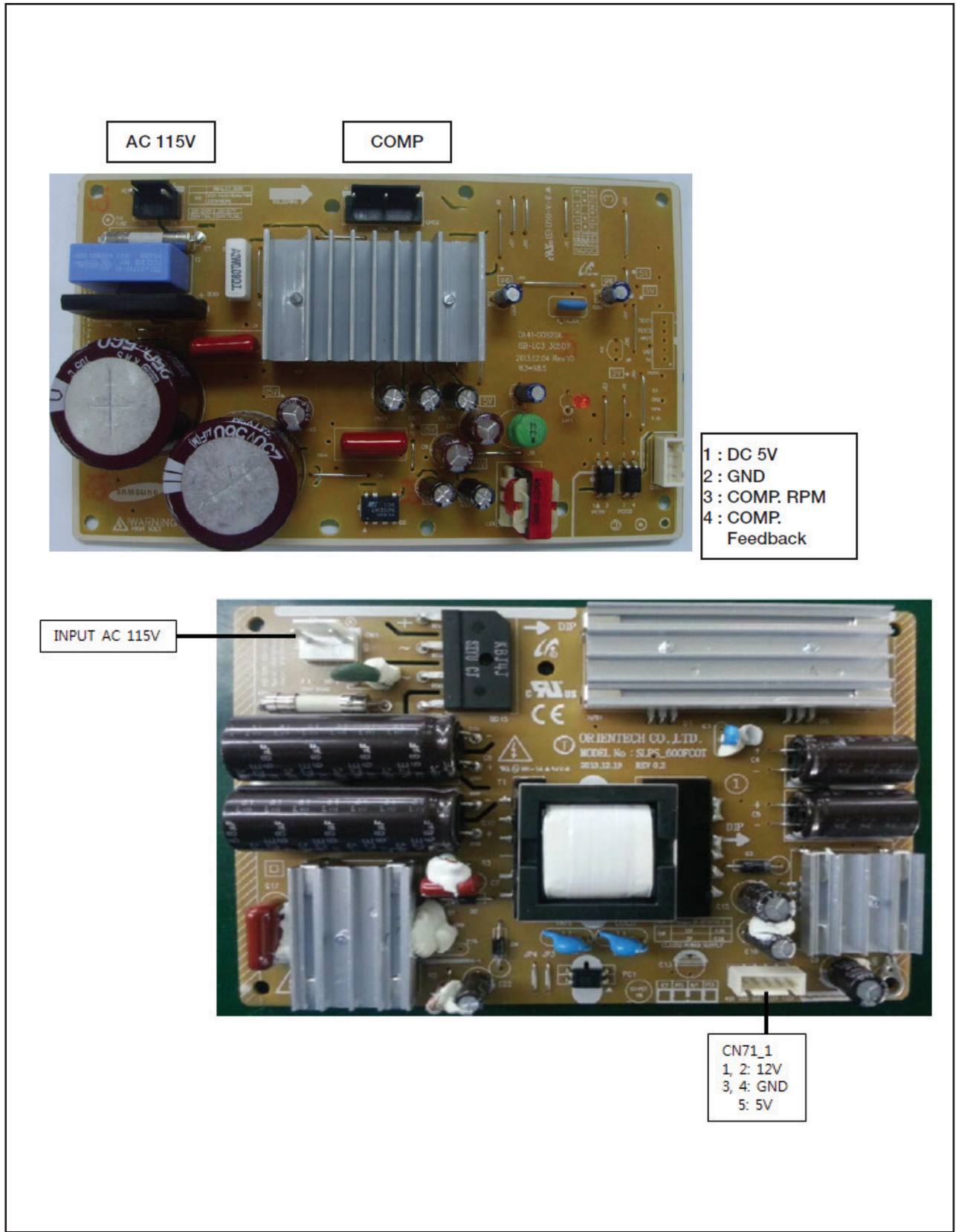

7. WIRING DIAGRAM

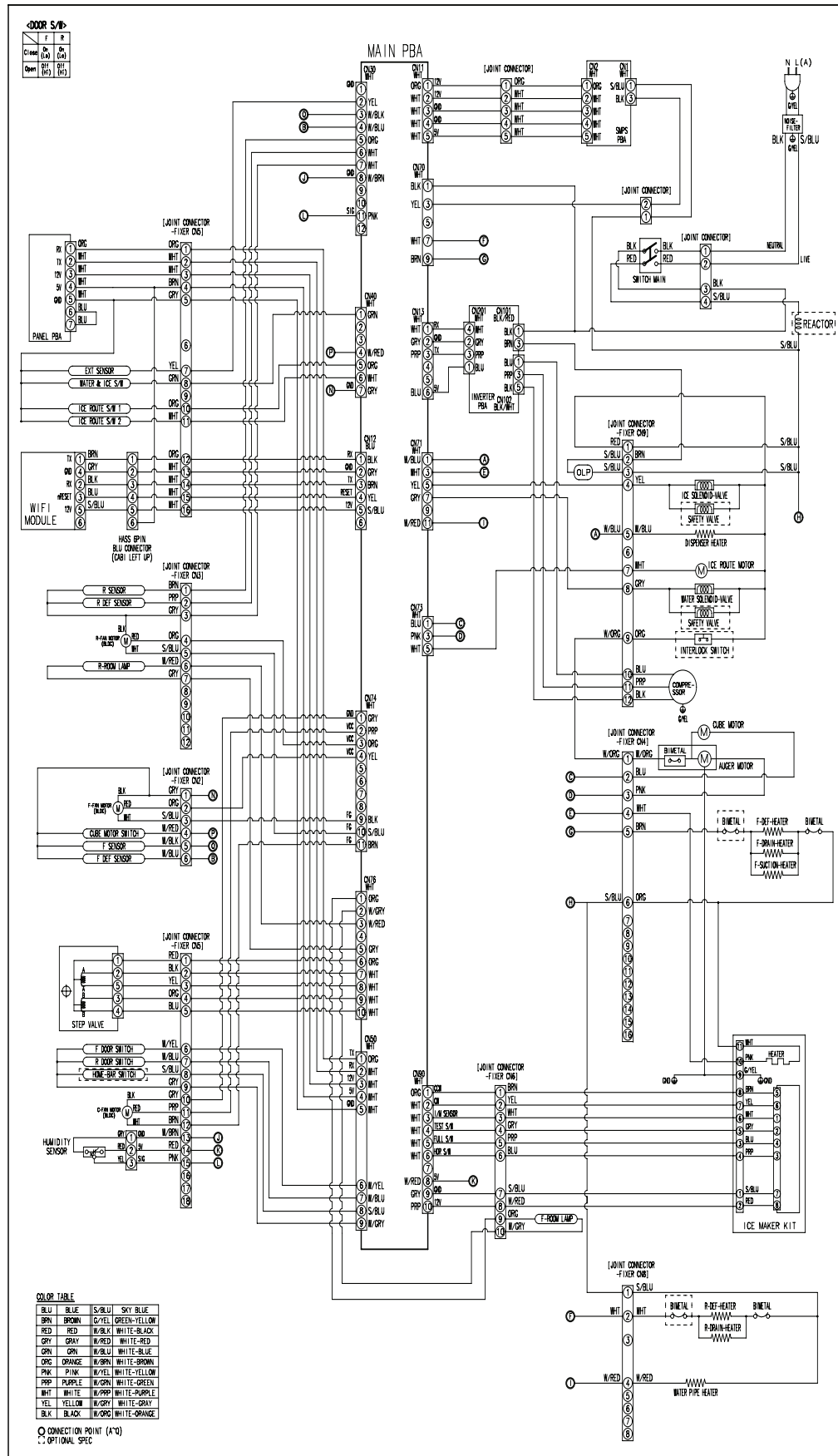

8. BLOCK DIAGRAM

8-1) Whole block diagram

MAIN BLOCK

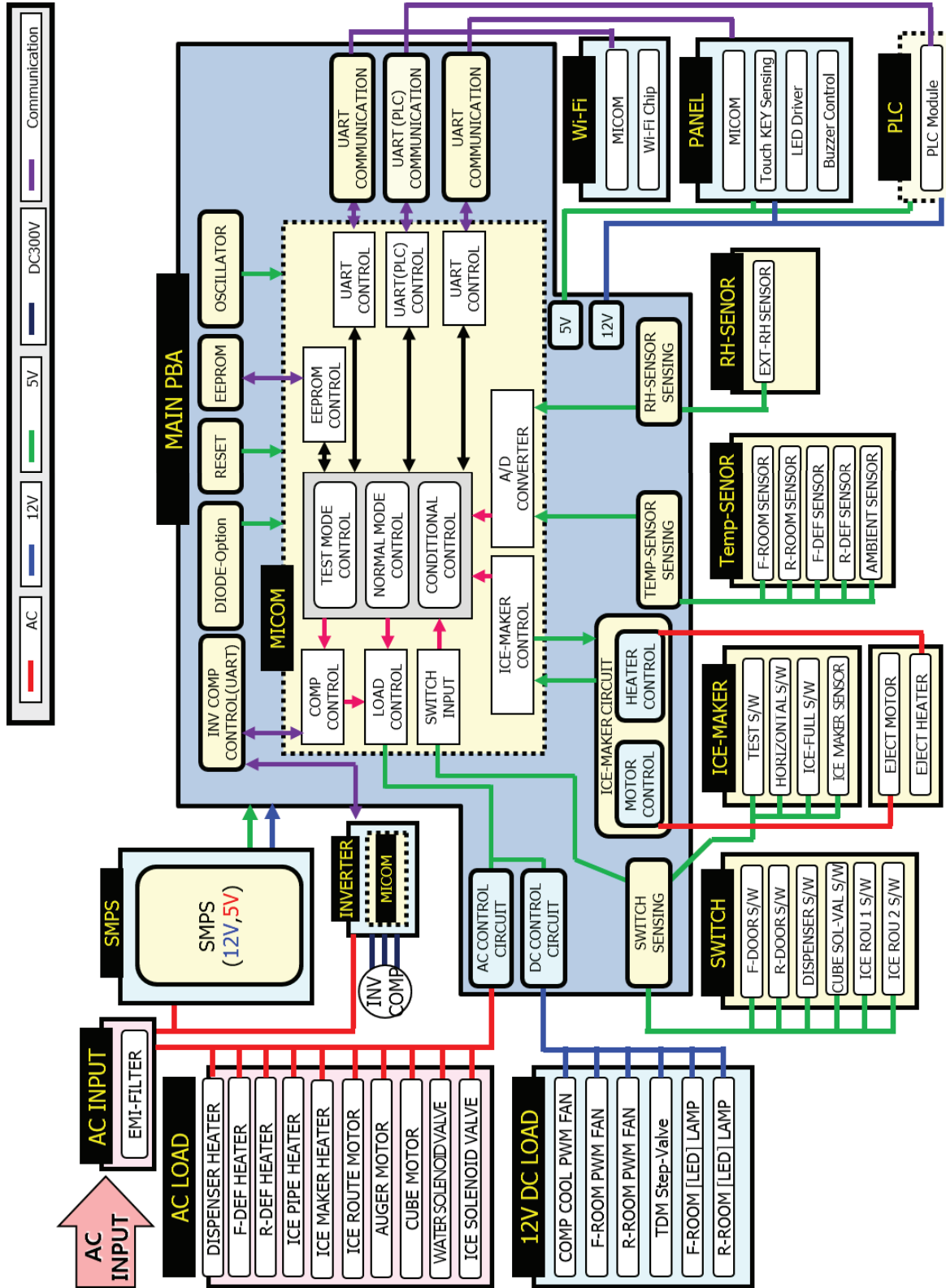

9. REFERENCE INFORMATION

9-1) Trouble Shooting

PROBLEM	SOLUTION
The Refrigerator does not work at all or it does not chill sufficiently.	<ul style="list-style-type: none"> • Check that the power plug is properly connected.
	<ul style="list-style-type: none"> • Check the set temperature on the digital display is warmer than freezer or fridge inner temperature.
	<ul style="list-style-type: none"> • Try setting it to a lower temperature.
	<ul style="list-style-type: none"> • Is the Refrigerator in direct sunlight or located near a heat source?
	<ul style="list-style-type: none"> • Is the back of the Refrigerator too close to the wall and therefore keeping air from circulating?
The food in the Refrigerator is frozen.	<ul style="list-style-type: none"> • Check the set temperature on the digital display is too low.
	<ul style="list-style-type: none"> • Try setting it to a warmer temperature.
	<ul style="list-style-type: none"> • Is the temperature in the room too low? Try setting it to a warmer temperature.
	<ul style="list-style-type: none"> • Did you store the food which is juicy in the coldest part of the Refrigerator? Try moving those items on the other shelves in fridge instead of keeping them in the Cool Select Pantry™.
You hear unusual noise or sounds.	<ul style="list-style-type: none"> • Check that the Refrigerator is level and stable.
	<ul style="list-style-type: none"> • Is the back of the Refrigerator too close to the wall and therefore keeping air from circulating?
	<ul style="list-style-type: none"> • Try locate the refrigerator keep away from the wall over 2 inches.
	<ul style="list-style-type: none"> • Was anything dropped behind or under the Refrigerator?
	<ul style="list-style-type: none"> • A “ticking” sound is heard from inside the Refrigerator. It is normal and occurs because various accessories are contracting or expanding according to the temperature of the Refrigerator interior.
The front corners and vertical hinged section of the appliance are hot and condensation is occurring.	<ul style="list-style-type: none"> • Some heat is normal as anti-condensators are installed in the vertical hinged section of the Refrigerator to prevent condensation.
	<ul style="list-style-type: none"> • Is the Refrigerator door ajar? Condensation can occur when you leave the door open for a long time.
	<ul style="list-style-type: none"> • If a sound that hit something is heard from inside the refrigerator, it is normal and occurs because ice dropping make a sound by periods.

REFERENCE INFORMATION

PROBLEM	SOLUTION
Ice Maker is not producing ice.	<ul style="list-style-type: none"> • Did you wait for 12 hours after installation of the water supply line before making ice?
	<ul style="list-style-type: none"> • Is the water line connected and the shut-off valve opened?
	<ul style="list-style-type: none"> • Is the Freezer temperature too warm? Try setting the Freezer temperature lower.
You can hear water bubbling in the Refrigerator.	<ul style="list-style-type: none"> • This is normal. The bubbling comes from the Refrigerator coolant liquid circulating through the Refrigerator.
There is a bad smell in the Refrigerator.	<ul style="list-style-type: none"> • Check for spoiled food.
	<ul style="list-style-type: none"> • Foods with strong odors(for example, fish) should be tightly covered.
	<ul style="list-style-type: none"> • Clean out your Freezer periodically and throw away any spoiled or suspicious food.
Frost forms on the walls of the Freezer	<ul style="list-style-type: none"> • Is the air vent blocked? Remove any obstructions so air can circulate freely.
	<ul style="list-style-type: none"> • Allow sufficient space between the foods stored for efficient air circulation.
	<ul style="list-style-type: none"> • Is the Freezer drawer closed properly?
Water dispenser is not functioning.	<ul style="list-style-type: none"> • Is the water line connected and the shut-off valve opened?
	<ul style="list-style-type: none"> • Has the water supply line tubing been crushed or kinked? Make sure the tubing is free and clear of any obstruction.
	<ul style="list-style-type: none"> • Is the water tank frozen because the Refrigerator temperature is too low? Try selecting a warmer setting on the Digital display.

REFERENCE INFORMATION

9-2) Q&A

Descriptions of symptoms	Check Points	Corrective Measures
<p>► Noise (resonance) problems keep on even though the noise generating BLDC motors for both of the compartments are replaced several times. What does generate the resonance and how can it be settled down?</p>	<p>When the BLDC fan motor rotates in low RPM, The friction with air is quite high and it generates “grinding” noises.</p>	<p>If you replace the ambient thermistor with a 2.7K resistance (detecting 109.4°F), the BLDC fan motor rotates in high RPM, which reduces friction with air resulting in reduction of the “grinding” resonance.</p>
<p>► What causes the “knocking” noises? How to solve it?</p>	<p>It makes “knocking” or “branch breaking” noises when the liner and the shelves hit each other due to the fluctuation of the inside air pressure upon door open/close. Also, these noises occur when the liners and the shelves hit each other as the liners expand and contract due to the temperature change in both of the compartments.</p>	<p>Check the clearance between the selves and the liners.</p> <p>① Freezer Shelves: Remove the trim shelves already attached and replace them with those supplied for service.</p> <p>② Fridge Shelves: Because noise-preventing trim selves are not attached, it needs attaching.</p>
<p>► What is the solution if the same problem occurs even though the counter action in the service bulletin has been implemented already for the “knocking” noises?</p>	<p>Check if the selves wobble. If they do, have shelves sit firmly on their places.</p>	
<p>► What causes the liquid passing noises from the back of the refrigerator?</p>	<p>Refrigerant goes into the evaporator via the capillary tube in which the refrigerant expands as it circulates the cooling cycle. At this time, the refrigerant is in its liquid state and it starts evaporating as it reaches at the inlet of the evaporator with a bigger diameter, which causes the refrigerant noises. And, it gets worse when the refrigerant does not flow freely.</p>	

REFERENCE INFORMATION

Descriptions of symptoms	Check Points	Corrective Measures
<p>► What is the solution for the compressor noises?</p>	For new refrigerators	
	Check if the refrigerator is leveled.	Check if the refrigerator wobbles by shaking with hands.
	Check if there is enough clearance at the back of the refrigerator for the ventilation of the machine compartment.	If there is not enough clearance or it is blocked by things such as newspaper, there could be resonance noises.
	Required clearance around the product.	More than 2 inches from the back, 12 inches from the top and 4 inches from its sides.
<p>► What is the solution for the compressor noises?</p>	For old refrigerators	
	Dust could get built-up in the machine compartment. Then, its ventilation would get restricted which makes the refrigerator overheated resulting in the increase of the noise level.	Explain it to customers and let them clean dust or any other foreign substances in the machine compartment.
	As the vibration proof rubbers get hardened, noises generate during the comp operation. (The noise level is quite high.) → Replace the vibration proof rubbers.	The compressor is dislocated due to impact during its transportation such as moving-in. → Check if it's dislocated when it is more noisy after moving-in.
<p>► During the comp start-up, iron friction noises occur. What causes them?</p>	The reciprocation piston could get worn out or inner components could get dislocated.	
<p>► What can be checked when the unit sends out noises?</p>	<ol style="list-style-type: none"> 1. Check its symptoms and patterns. 2. Check if the unit is installed on a firm and leveled floor. 3. Check if the unit is installed close to the customer's living area. 4. Check if the panel on the machine compartment hits on the rear wall and the unit has enough clearance with the rear wall. 5. Check if the refrigerant pipes are shaped as normal. 	

REFERENCE INFORMATION

Descriptions of symptoms	Check Points	Corrective Measures
<p>▶ Why is the fridge compartment not cool? (Not a defect)</p>	<p>Advise customers to adjust its temperature level to one or two step higher. For example, when the ambient temperature is low such as in winter (especially, when you use it in the morning with the door not being opened or closed during the night), the compartment temperature could get increased by 33.8~35.6°F. So, advise customers to shift its temperature level and explain to them that it does not affect its power consumption that much when its temperature setting is adjusted to one or two step lower.</p>	
<p>▶ Why is the food melt even though the display of the freezer compartment shows -4°F?</p>	<p>Check the compartment temperature with a thermometer.</p>	<p>If it is considered to be low cooling, When the BLDC motor fan does not rotate because its restriction is not picked up. When the evaporator is frozen-up (defrost it) Temp detection error according to the characteristic change of the thermistor (set the compartment temperature or replace the thermoistor)</p>
<p>▶ What is the reason that vegetables get frozen even though the fridge compartment is set to MIN?</p>	<p>Replace the fridge thermistor because it could be faulty. 1st: Check if the thermistor works after referring to the self-diagnosis checklist on the MAIN-PCB cover. If the over-cooling keeps on even though there is no problem with the above, replace it.</p>	
<p>▶ What can be done when frozen food gets melt in the freezer compartment or it does not cool down?</p>	<p>Defrost it by using hot water and check the defrost system for any fault. And then, eliminate the root causes so as to prevent it from reoccurring.</p>	
<p>▶ Why doesn't the compressor operate upon power supply?</p>	<p>Upon the initial power on, the compressor starts operating after a five minute delay to protect the compressor. So, please wait until it starts operating.</p>	
<p>▶ Why does it send out "Ding Dong" or alarm sounds with the doors closed?</p>	<p>Check if the food sticks out preventing the doors from closing properly. If it send out the above sounds with the door closed well, the door switch may not have been pressed down completely. So, make sure for the door switches to be pressed completely. Still, if it does not stop going off, check the wiring connections because the door switch signals may not be inputted into the PCB. And, when the door switch is faulty or it is not pressed down completely, the fan does not rotate and it causes low-cooling advancing to a defrost problem.</p> <p>Note : When it comes to automatic models, the fan motor does not operate right on with the door closed after being opened. The fan motor for dual-evaporator refrigerators starts after a 50°F~second delay and when the ambient temperature is higher than 91.4°F, it starts after a minute.</p>	

REFERENCE INFORMATION

Descriptions of symptoms	Check Points	Corrective Measures
<p>► What can be done when it sends out much smell in the fridge and the freezer compartments after 2 months?</p>	<p>When the stored food sends out much smell.</p> <ul style="list-style-type: none"> ☞ Check if there is any food sending out sustaining smells. Dried squid, dried laver : Hold on them Pounded garlic : Put it in an airtight container Medical herbs : Make sure they are packed airtight. Replace the old packing or wrap with a new one. Others : Check if the container is sealed or the food is packed airtight. ☞ Check if the compartment temperature is normal and the food is contaminated. ☞ Check if there are any overflow of side dishes on the shelves or the bottom of the compartments. ☞ Put the food sending out much smell in an airtight bag or container. ☞ Open the door and ventilate it. Also, clean liners, shelves, containers and door bins. 	
<p>► What is the cause and its counter action for chemical smells with new products?</p>	<p>During its delivery to customers, chemical smells from various components could build up inside of the compartments. So, please let the doors open for some time to use the unit.</p> <p>Precautions : Smells tend to get soaked into the liners or other components. If food generating much smell is stored inside, it would stick onto the liners and other components and it is so difficult to remove the smell. Especially, customers should take care in storing smelly food properly with its sealing being tight during the early period of the product's use.</p>	
<p>► What can be done when the smell keeps on even though the deodorizers are cleaned?</p>	<ol style="list-style-type: none"> 1) Turn off the refrigerator (unplug the unit) and remain the door opened. 2) Take out the food stored in the refrigerator. And then, take out all the shelves, door bins and containers, and put them in warm water. After cleaning them by using dish detergents and drying them, put them back to their locations. 3) Remove the deodorizer and soak it in warm water more than 4 hours. After drying it in sunlight, put it back to its location. 4) Throw away the smell-soaked plastic bags and put the food in new ones. 	
<p>► What causes the funny smell in water?</p>	<p>When it tastes and smells funny</p> <ul style="list-style-type: none"> ☞ It tastes funny even though it does not smell funny. 	<p>It could happen when remnants of the water filter or organics have been built up in the water tank. So, replace the water filter and the water tank together. If there is no replacement part and the water tank need cleaning, use dish detergents and make sure to clean the inside without any detergents remaining inside.</p>



272, Oseon-Dong, Gwangsan-Gu,
Gwangju-City, Korea, 506-253
TEL : 82-62-950-6193, 6896
FAX : 82-62-950-6829

Europe, CIS, Mideast & africa : gspn1.samsungcsportal.com
Asia : gspn2.samsungcsportal.com
North & Latin America : gspn3.samsungcsportal.com
China : china.samsungportal.com

- This Service Manual is a property of Samsung Electronics Co., Ltd.
Any unauthorized use of Manual can be punished under applicable
International or domestic law.