

SAMSUNG

GAS RANGES

MODELS AND

MODEL CODES : DOP30T840GS/**

SERVICE Manual

GAS RANGES

CONTENTS

1. Precaution
2. Specifications
3. Disassembly and Reassembly
4. Troubleshooting
5. Wiring Diagram
6. PCB Diagrams

Disclaimer:

This manual contains confidential and proprietary information of Samsung Electronics Co., Ltd. ("Samsung")

All text, graphics, user interfaces, visual interfaces, photographs, trademarks, and logos (collectively, "Content"), including but not limited to the design, structure, selection, coordination, "look and feel" and arrangement of such Content, contained in this manual is owned, controlled or licensed by or to Samsung, and is protected by trade dress, copyright, patent and trademark laws, and various other intellectual property rights and unfair competition laws.

No part of this manual or the Content may be copied, reproduced, republished, uploaded, posted, publicly displayed, encoded, translated, transmitted or distributed in any way (including "mirroring") to anyone, any entity, any other computer, server, Web site or other medium for publication or distribution or for any commercial purpose, without Samsung's express prior written consent.

Samsung reserves the right, at its sole discretion, to change, modify, add or remove portions of any part of this manual at anytime. It is your responsibility to check the manual periodically for changes. Your use of the manual will mean that you accept and agree to this disclaimer. If you do not agree with any part of this disclaimer, please stop using this manual immediately.

• Contents

1. Precaution	5
1-1 Forward	5
1-2 Safety Precautions.....	5
1-3 Important Safety Instructions	6
1-4 Model and Serial Number Label and Tech Sheet Locations	8
2. Soecifications	9
2-1 New Appearance Design	9
2-2 Oven Features.....	9
2-3 Control Panel - Oven.....	10
2-4 Control Panel - Gas Cooktop	11
2-5 Table of Specifications	12
2-6 Accessories	15
3. Disassembly and Reassembly	17
3-1 BASIC STEP	18
3-1-1 (Step A) - COVER BACK.....	18
3-1-2 (Step B) – ASSY CONTROL BOX	19
3-1-3 (Step C) – ASSY FRAME COOKTOP	20
3-1-4 (Step D) - Oven Door.....	24
3-1-5 (Step E) - Side Panel	26
3-1-6 (Step F) – ASSY COOKTOP BURNER	27
3-1-7 (Step G) – ASSY DRAWER	29
3-2 Component replacement Step.....	30
3-2-1 MAIN PCB ASSEMBLY	30
3-2-2 ASSY DISPLAY MODULE	34
3-2-3 ASSY MODE S/W & ASSY TEMPS/W.....	36
3-2-4 KNOB LED PCB.....	37
3-2-5 ELECTRODE.....	38
3-2-6 BURNER CUP	40
3-2-7 GAS ORIFICE NOZZLE (Stack Burner).....	42
3-2-8 GAS ORIFICE NOZZLE (Dual Burner)	43
3-2-9 VALVE COOKTOP	44
3-2-10 SWITCH IGNITION	45
3-2-11 ASSY MOTOR	46
3-2-12 ASSY DOOR LATCH.....	47
3-2-13 SWITCH-DOOR PLUNGER	48
3-2-14 ASSY LAMP	49
3-2-15 SENSOR-THERMISTER.....	50
3-2-16 GASKET DOOR	51
3-2-17 HANDLE-DOOR, GLASS INNER	52
3-2-18 ASSY POWER CORD	55
3-2-19 BURNER BROIL	56
3-2-20 HOT SURFACE IGNITOR (HSI) of the BURNER BROIL, NOZZLE BROIL, HOLDER NOZZLE BROIL	58
3-2-21 BURNER BAKE	60
3-2-22 HOT SURFACE IGNITOR (HSI) of the BURNER BAKE, NOZZLE BAKE-BURNER, HOLDER BAKE-BURNER	62
3-2-23 ASSY VALVE SAFETY	63
3-2-24 SUPPORT RACK LEFT/RIGHT	65
3-2-25 ASSY VALVE REGULATOR	66

• Contents

4. Troubleshooting	68
4-1 Failure Display Codes	68
4-2 Control parts	84
4-3 Cooktop parts	87
4-4 Oven parts	93
5. Wiring Diagram	100
5-1 Wiring Diagram	100
6. PCB Diagrams	101
6-1 Main PCB	101
6-2 Sub PCB	102
6-3 Display PCB	103
6-4 PCB & Touch Keypad	104
6-5 PCB parts	106

SAMSUNG PROPRIETARY. DO NOT COPY OR DISTRIBUTE WITHOUT PERMISSION

1. Precaution

1-1 Forward

This SAMSUNG Service Manual, "Slide In Gas Ranges," provides the technician with information on the operation and service of the slide in self-cleaning gas ranges. It is to be used as a training service manual. For specific information on the model being serviced, refer to the user manual or tech sheet provided with the gas range.

1-2 Safety Precautions

- Repairs of the appliance should be carried out by a licensed technician only. Incorrect repairs may result in dangerous situations. If you need repairs, contact a SAMSUNG Service Center or your dealer.
- If the power cord is defective, it must be replaced by a licensed technician with a UL-listed range cord.
- If the gas supply is damaged or defective, it must be replaced by a licensed technician or gas supplier.
- Electrical leads and cables should not be allowed to touch the oven.
- Rating plate is located on the left side of the opening for the warming drawer or storage drawer.
- The gas and electrical supplies to the appliance should be turned off and/or disconnected when the range is being serviced or repaired.



WARNING

- To avoid risk of death or severe personal injury from electrical shock, disconnect power before working on/servicing the appliance.
- To avoid risk of death, severe personal injury, or property damage from fire or explosion, turn off the gas supply before working on/servicing the appliance. **IF YOU SMELL GAS:**
 1. **DO NOT** light a match, candle, or cigarette.
 2. **DO NOT** turn on any gas or electric appliances.
 3. **DO NOT** touch any electrical switches.
 4. **DO NOT** use any type of phone in the building.
 5. Clear the room, building, or area of all occupants.
 6. Immediately call the gas supplier from a phone outside of the building. Follow the gas supplier's instructions.
 7. If you cannot reach the gas supplier, call the fire department.
- To avoid risk of death, severe personal injury, or property damage from fire or explosion, do not wear loose-fitting, or hanging garments near an open flame during operation and/or servicing the appliance.
- When the oven operates, the interior parts will be very hot.

SAMSUNG Electronics assumes no responsibility for any repairs made on our products by anyone other than authorized service technicians.

1. Precaution

1-3 Important Safety Instructions

Read and follow all instructions before using or servicing the range to prevent death, personal injury, fire, explosion, and/or property damage. This guide does not cover every possible condition that may occur. For further assistance, contact a licensed technician or the manufacturer.

All electrical and gas equipment and their moving parts can be dangerous. Please read the important safety information on the appliance and in this manual. The information must be followed to minimize the risk of death, personal injury, and/or property damage.



This is the safety alert symbol. It alerts you of potential hazards that can kill or injure you or others. The following safety messages explain the potential hazards:



DANGER

Hazardous situation that will result in death and/or serious personal injury.



WARNING

Hazardous situation that could result in death, serious personal injury, and/or property damage.



CAUTION

Hazardous situation that may result in moderate personal injury, and/or property damage.

- Be sure your appliance is properly installed and grounded by a licensed technician.
- Do not repair or replace any part of the appliance unless specifically recommended in the manual. All other servicing should be referred to a licensed technician.
- Always disconnect power to the appliance before servicing by turning off the circuit breaker or removing the fuse.
- Always turn off the main gas supply to this appliance before servicing by closing the gas supply valve to this appliance.
- Always check gas fittings and components for leaks before servicing the appliance. If a leak is detected, shut off the gas supply and notify a licensed technician and/or gas supplier.



WARNING



- INJURIES CAN OCCUR IF THE RANGE TIPS
- INSTALL ANTI-TIP DEVICE PACKED WITH RANGE



- FOLLOW ALL INSTALLATION INSTRUCTIONS

To reduce the risk of tipping the range, the range must be secured by a properly installed anti-tip device. To check if the bracket is installed properly:

- Warming drawer: Grasp the top rear edge of the range and carefully attempt to tilt it forward. Verify that the anti-tip device is engaged.
- Storage drawer: Remove drawer and verify leveling leg is inserted into and fully secured by the anti-tip device.

Refer to the installation manual for proper anti-tip bracket installation.

- Do not step, lean, or sit on the doors of the range. This can cause the range to tip, resulting in burns or serious injuries.



WARNING

- **DO NOT TOUCH SURFACE BURNERS, SURFACE BURNER GRATES, OVEN BURNERS, INTERIOR SURFACES OF OVEN, OR WARMING DRAWER HEATING ELEMENT** – Burners, heating element, and surfaces may be hot even though they are dark in color. Interior surfaces of an oven become hot enough to cause burns. During and after use, do not touch or let clothing or other flammable materials contact burners, heating element, grates, or interior surfaces of oven until they have had sufficient time to cool. Other surfaces of the appliance may become hot enough to cause burns. Among these surfaces are oven vent openings and surfaces near these openings, oven doors, and windows of oven doors.

1. Precaution



CAUTION

Do not store items of interest to children in cabinets above a range or on the backguard of a range – Children climbing on the range to reach items could be seriously injured.

- **Do Not Leave Children Alone** – Children should not be left alone or unattended in the area where the appliance is in use. They should never be allowed to sit or stand on any part of the appliance.
- **Never Use Your Appliance for Warming or Heating the Room.**
- **Storage in or on Appliance** – Flammable materials should not be stored in an oven or near surface units. Be sure all packing materials are removed from the appliance before operating it. Keep plastics, clothes, and paper away from parts of the appliance that may become hot.
- **Wear Proper Apparel** – Loose-fitting or hanging garments should never be worn while using the appliance.
- **Do Not Use Water on Grease Fires** – Turn off the oven to avoid spreading the flame. Smother the fire or flame by closing the door or using baking soda or a dry-chemical or foam-type extinguisher.
- **Use Only Dry Pot Holders** – Moist or damp pot holders on hot surfaces may result in burns from steam. Do not let the pot holder touch hot heating elements. Do not use a towel or other bulky cloth.



WARNING

SURFACES

- **DO NOT TOUCH SURFACE BURNERS OR AREAS NEAR BURNERS** – Surface burners may still be hot after they have been turned off. Areas near surface burners may become hot enough to cause burns. During and after use, do not touch or let clothing or other flammable materials contact surface burners or areas near burners until they have had sufficient time to cool. Among these areas are the cooktop, surface burner grates, and surfaces close to the cooktop.



WARNING

To avoid risk of death or personal injury from electrical shock, make sure your range has been properly grounded and always disconnect it from the main power supply before any servicing.

SURFACE BURNERS

- **Use Proper Pan Size** – This appliance is equipped with one or more surface burners of different sizes. Select utensils having flat bottoms large enough to cover the surface burner flames. The use of undersized utensils will expose a portion of the surface burner flames to direct contact and may result in ignition of clothing. Proper relationship of utensil to burner will also improve efficiency.
- **Never Leave Surface Burners Unattended at High Heat Settings** – Boilovers could ignite or extinguish the burner flames. Both conditions create an explosion and/or fire hazard.
- **Protective Liners** – Do not use aluminum foil to line cooktop surface or oven bottoms, except as suggested in the manual. Improper installation of these liners may result in a risk of electric shock, fire, or burner damage.
- **Glazed Cooking Utensils** – Only certain types of glass, glass/ceramic, ceramic, earthenware, or other glazed utensils are suitable for range-top service without breaking due to the sudden change in temperature.
- **Utensil Handles Should Be Turned Inward and Not Extend Over Adjacent Surface Burners** – To reduce the risk of burns, ignition of flammable materials, and spillage due to unintentional contact with the utensil, the handle of a utensil should be positioned so that it is turned inward and does not extend over adjacent surface burners.
- **Surface Burner Components** – The burners, burner caps, and burner cups should always be cleaned by hand. They are not dishwasher-safe. The orifices should always be checked for dirt and debris whenever the burner cups are cleaned.
- Be sure you know which control knob operates each surface burner. Make sure you turned on the correct surface burner.

COOKTOP COOKING SURFACES

- **Clean Cooktop With Caution** – If a wet sponge or cloth is used to wipe spills on a hot cooking area, be careful to avoid a steam burn. Some cleaners can produce noxious fumes if applied to a hot surface.
- Clean the cooktop surface with a nonabrasive cleaner on painted metal surfaces.

VENTILATING HOODS:

- **Clean Ventilating Hoods Frequently** – Grease should not be allowed to accumulate on hood or filter.
- **When flaming foods under the hood, turn the fan on.**

DEEP-FAT FRYERS:

- Use extreme caution when moving the grease kettle or disposing of hot grease.

1. Precaution

SELF-CLEAN OVENS



CAUTION

- BEFORE CLEANING, REMOVE BROILER PAN, OVEN RACKS, AND UTENSILS.
 - WIPE EXCESS SPILLS FROM OVEN INTERIOR.
 - SEE USER INSTRUCTIONS.
- **Do Not Clean Door Gasket** – The door gasket is essential for a good seal. Care should be taken not to rub, damage, or move the gasket.
 - **Do Not Use Oven Cleaners** – No commercial oven cleaner or oven liner protective coating of any kind should be used in or around any part of the oven.
 - **Never keep pet birds in the kitchen** – The health of birds is extremely sensitive to the fumes released during an oven self-clean cycle. Fumes may be harmful or fatal to birds. Move birds to a well-ventilated room.
- **Important Instruction** – In the event the self-clean mode “F” code goes on or three long beeps sound, the oven is malfunctioning in the self-clean mode. Turn off or disconnect appliance from electrical and gas supplies and have the appliance serviced by a licensed technician.
 - **Use Care When Opening Door** – Let hot air or steam escape before you remove or replace food in the oven.
 - **Do Not Heat Unopened Food Containers** – Buildup of pressure may cause container to burst and result in injury.
 - **Keep Oven Vent Ducts Unobstructed** – The oven vent is located above the left-rear surface unit. This area could become hot during oven use. Never block this vent and never place plastic or heat-sensitive items near the vent.
 - **Placement of Oven Racks** – Always place oven racks in the desired location while the oven is cool. If a rack must be moved while the oven is hot, do not let the pot holder contact a hot oven burner or oven bottom.

1-4 Model and Serial Number Label and Tech Sheet Locations

These models have Model/Serial Number labels and Tech Sheets located as shown below.



Model and Serial Number Location

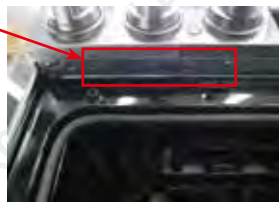

2. Specifications

2-1 New Appearance Design

- Air Sous Vide
- Air Fry
- 23K BTU Dual Burner
- Dual Fan Convection
- All Dual Brass Burner

2-2 Oven Features

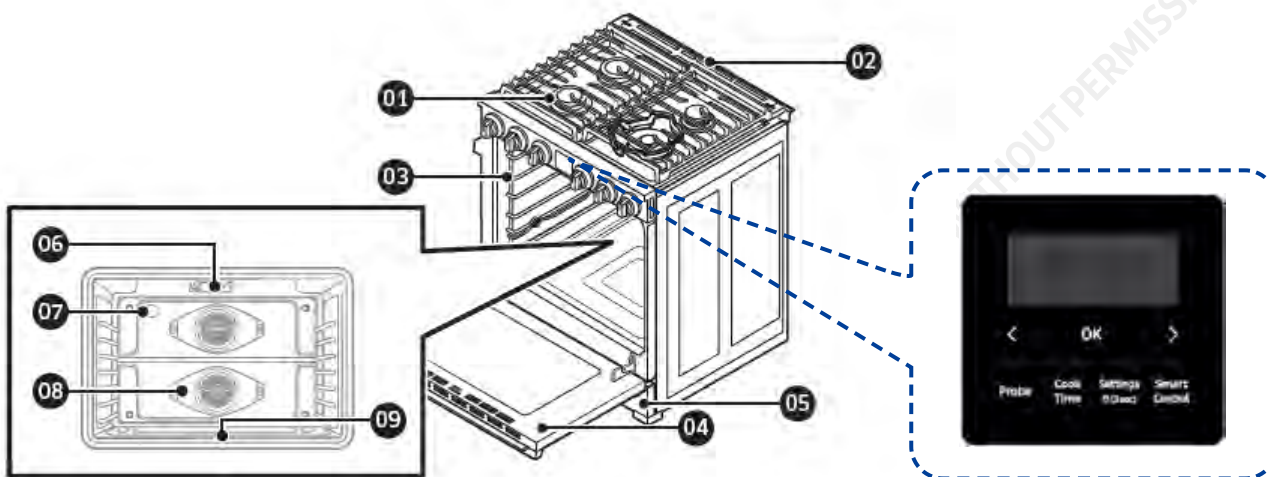

01	Surface burners	02	Oven Vents cover
03	Ladder racks	04	Removable oven door
05	Storage drawer	06	Broil oven burner
07	Oven light (1 locations)*	08	Convection fan
09	Bake oven burner		

2. Specifications

2-3 Control Panel - Oven

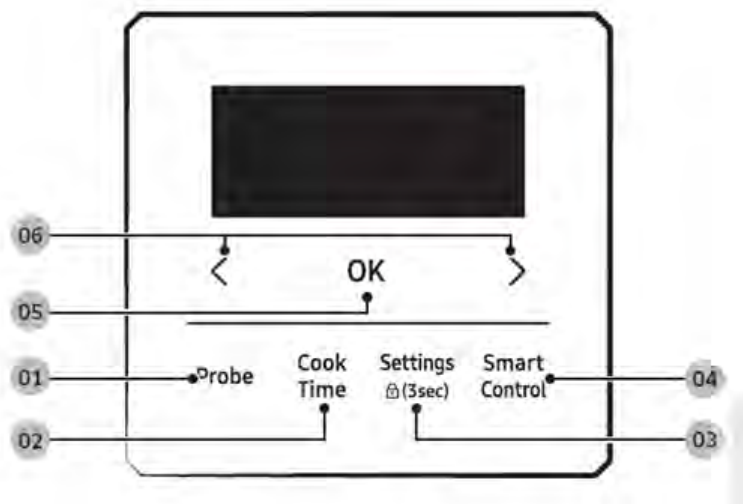

01	Probe	Activate the temperature probe mode.
02	Cook Time	Set the cooking time.
03	Settings	Display the user options available.
04	Smart Control	Set Smart control function ON/OFF.
05	OK	Start a function or set the time.
06	<, >	Select a function or set time.

2. Specifications

2-4 Control Panel - Gas Cooktop

LIGHTING A GAS SURFACE BURNER

Make sure all surface burners are positioned and assembled properly.

1. Push in and turn the control knob to the LITE position.
You will hear a "clicking" sound indicating the electronic ignition system is working properly.
2. After the surface burner lights, turn the control knob to adjust the power setting of the surface burner and turn off the electronic ignition system

- ☑ If the control knob is left in the Lite position, the electronic ignition system will continue to click and spark. It is not recommended to operate any surface burner in the Lite position, since all electronic igniters spark at the same time.

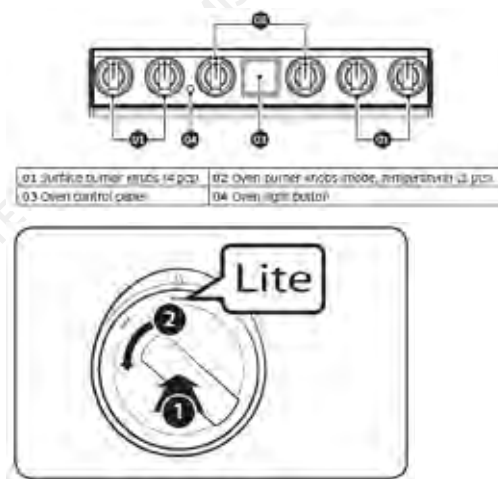

GAS SURFACE BURNERS AND CONTROL KNOBS

Your gas range cooktop has five gas burners. All cooktop burners are open-port design to provide you easy assembly and accurate and dependable operation. The different burner sizes ensure you have the proper heat source for the desired cooking job.

The 9,500 BTU burner provides precise cooking performance for delicate foods and foods that require low heat for long cooking times. The 9,500 BTU burner allows the LO setting to be used for a very low simmer setting.

The 16,000 BTU round burners are general-purpose burners that can be used for most cooking. The HI to LO settings provide a wide range of cooking temperatures to meet your cooking needs.

The 20,000 BTU burner provides maximum output. These burners can also be used as general-purpose burners, but they are designed to provide quick heat to large cookware.

The 20,000 BTU burner spreads out the heat with a larger circle of flames.

This provides better heat distribution for larger cookware (12 in [30.5 cm]) or larger pots and pans.

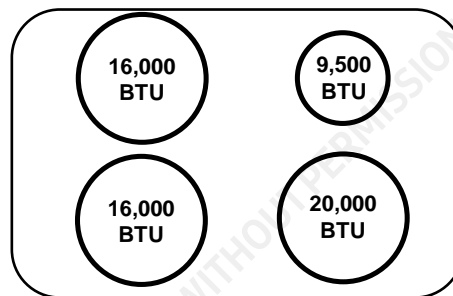

2. Specifications

2-5 Table of Specifications

Model	DOP30T840GS/DA	
Cavity		
Cavity Color	Black	
Size	Whole Oven(Cu.ft)	6.0
	Drawer (Cu.ft)	1.0
Base		
Cooktop	Knob Feature	Anodizing
	Cooktop Frame	Black Porcelain Enamel
	Illuminated Knobs	Yes
	Welcome Lighting (Ambient)	0
	Re-ignition	0
Control	Display Design	2.25" LCD
	Control Type	Glass Touch
	Display Color	White
	Display Language	EN
	Control Language	EN
Cleaning	Self Clean	0 (2/3/5 hrs)
	Green Clean	-
Exterior	Art Long Hairline	0
Cooktop		
Grate	Edge-to-Edge	
Burner Spec	Number of Burners	4
	TTL Power	61.5K BTU
	Left Front	16K (Dual Valve, Brass, Stack Burner)
	Left Rear	16K (Dual Valve, Brass, Stack Burner)
	Right Front	20K, Double (Dual Valve- Brass)
	Right Rear	9.5K (Dual Valve, Brass, Stack Burner)
	Burner - Body	All Brass
	Burner Cap	Black (All Burner)
Oven		
	Bake Element	18K BTU
	Broil Element	16.5K BTU (Gas)
	Convection Element	Dual Convection
	Convection Heater	900W
	Interior Light (Watts / Location)	1 Incandescent 40W / Back
	# of Rack Positions	7

2. Specifications

Model	DOP30T840GS/DA	
Oven - Cooking Mode		
Basic Function (Knob)	Bake	150°F (65°C) - 550°F (285°C) 350°F (175°C)
	Broil	High - Med - Low High
	Convection Bake	150°F (65°C) - 550°F (285°C) 325°F (160°C)
	Convection Roast	150°F (65°C) - 550°F (285°C) 325°F (160°C)
	Air Fry	350°F (175°C) - 500°F (260°C) 425°F (220°C)
	Stone Bake Mode	350°F (175°C) - 500°F (260°C) 425°F (220°C)
	Keep Warm	175°F (80°C)
Special Function	Dehydrate	150°F (65°C)
	Proof	95°F (35°C)
	Air Sous Vide	100°F (40°C) - 205°F (95°C) 150°F (65°C)
Clean	Self Clean	
Oven Control Feature		
Touch Control	Cook Time	0
	Timer Off(3sec)	0
	Delay Start	0
	Temp Probe	0
	Clock	0
	Light On/Off	0
	Child Lock(3sec)	0
	IQ Control	0
	Touch to wake-up	0
Extra Features	Temp. Adjustment (+/-35F)	0
	Temp Unit (C/F)	F Default
	Conv. Auto Conversion (Default:-25F)	X
	12 hour Energy Saving	0
	Sound On/Off	0
	Wi-Fi On/Off	0
	Demo Mode	0
	Sabbath	0
	Time 12Hr/24Hr	0
	Manual Language	EN/FR/ES
Oven Door		
	Door Screen Print	Smog
	Automatic Safety Door Lock	0
	Removable Oven Door	0
	Soft Close	0

2. Specifications



Model	DOP30T840GS/DA	
Drawer		
	Type	Storage
	Cavity Size(cu.ft)	1.0
	Drawer Rail	0
	Handle	None
Connectivity		
	Wi-Fi	0
	Voice Control(3rd Party)	0 (Bixby/Alexa/Google)
Accessories/Others		
Rack	Ladder Rack	0
	Number of Rack Position	7
	Number of Racks	4
	Gliding Rack	1
	Wire Rack(Flat/Broil Rack)	2
	Air Fry tray	1
	Meat Probe	1
	Griddle(Al/Cast Iron)	X
	Wok Grate	1
	Anti Tip Device	1
	Rear Kit	0
Smart Feature MRT		
Connection	Wi-Fi Type	0
	SmartThings	0
	bluetooth	0
Power		
	Input Power	120V/60Hz
	Circuit Breaker	40A
Dimension		
	Net Size (W x H x D) (inch/mm)	(29 15/16) x (36 1/4 ~ 37) x (28 11/16) inch (760.4) x (920.75 ~ 939.8) x (728.66) mm
	Shipping Size (W x H x D) (inch/mm)	(33 1/16) x (41 3/4) x (30 5/16) inch 839.8 x 1060.45 x 769.9 mm
	Cavity Size (W x H x D) (inch/mm)	25 x 21 1/2 x 19 3/8 (inch) 635 x 546.5 x 492 (mm)
	Net Weight (lbs/kg)	240.5 lbs / 109.1 kg
	Shipping Weight (lbs/kg)	269 lbs / 122.02 kg
	Loading Qty - 40ft HC	84
	Number of Rack Position	7

2. Specifications

2-6 Accessories

Item	Description	Code No.	Quantity
	ASSY GRATE SIDE-LEFT	DG94-05097A	1
	ASSY GRATE SIDE-RIGHT	DG94-05098A	1
	ASSY GRATE-WOK	DG94-01759A	1
	BRACKET COVER	DG61-01994B	1
	ASSY BRACKET SUB	DG94-00870B	1
	COVER-LEG	DG63-00854A	2
	Rack-Flat	DG67-00282A	2
	Gliding Rack	DG94-00908C	1
	Air Fry Rack	DG63-00700A	1





2. Specifications

Item	Description	Code No.	Quantity
	Filter	DG94-04671A	2
	Meat Probe	DG94-00674C	1
	Surface burners and caps	DG98-02466A	1

SAMSUNG PROPRIETARY. DO NOT COPY OR DISTRIBUTE WITHOUT PERMISSION

3. Disassembly and Reassembly

■ Tool for assembly and disassembly

Item	How to use	Pictures
Screw driver(+)	Use for assembly and disassembly of all screws	
Tubing Wrench	Use for assembly and disassembly of tubing to the cup	
7mm Vox Driver	Use for assembly and disassembly of injector nozzles. [cooktop/Broil/Bake burner]	
9mm Vox Driver	Use for assembly and disassembly of injector nozzles. [Convection Fan]	

SAMSUNG PROPRIETARY. DO NOT COPY OR DISTRIBUTE WITHOUT PERMISSION

3. Disassembly and Reassembly

3-1 BASIC STEP

3-1-1 (Step A) - COVER BACK

⚠ WARNING

Disconnect power before servicing the range. Replace all panels before operating range. Failure to do so can result in death or electrical shock.

⚠ WARNING

EXPLOSION, FIRE, AND ASPHYXIATION HAZARD

Shut off gas supply to the range before servicing. Check all gas lines and fittings for leaks before operating the range. Replace all panels before operating range. Failure to do so can result in death or personal injury from explosion, fire, or asphyxiation.

⚠ CAUTION

When you work on the gas range, be careful when handling sheet metal parts. Sharp edges may be present, and you can cut yourself if you are not careful.

Parts	Explanation Photo	Explanation
COVER BACK	 <p style="text-align: center;">Cover Back</p>	<ol style="list-style-type: none"> 1. Turn off the electrical supply going to the range. 2. Pull the range away from the wall so that you can access the rear panel. 3. Remove 2 screws from Cover Back. 4. Lift up Cover Back to unlock hooks and separate Cover Back

3. Disassembly and Reassembly

3-1-2 (Step B) – ASSY CONTROL BOX

! WARNING

Disconnect power before servicing the range. Replace all panels before operating range. Failure to do so can result in death or electrical shock.

! WARNING

EXPLOSION, FIRE, AND ASPHYXIATION HAZARD

Shut off gas supply to the range before servicing. Check all gas lines and fittings for leaks before operating the range. Replace all panels before operating range. Failure to do so can result in death or personal injury from explosion, fire, or asphyxiation.

! CAUTION

When you work on the gas range, be careful when handling sheet metal parts. Sharp edges may be present, and you can cut yourself if you are not careful.

Parts	Explanation Photo	Explanation
<p>ASSY CONTROL BOX</p>		<ol style="list-style-type: none"> 1. Remove 6 Knobs from the Assy Control Box. 2. Remove 2 screws next to the each 4 valve shafts (Total 8 pcs) 3. Open the Door and Remove 3 screws from the bottom of Assy Control Box. 4. Remove 3 screws from the top of Assy Control Box. 4. Lift the Assy Control Box slightly to separate from the range. (Assy Wire Main is still connected to the Assy Control Box) 5. Disconnect 2 wire connectors. 6. Remove the Assy Control Box from the range.

3. Disassembly and Reassembly

3-1-3 (Step C) – ASSY FRAME COOKTOP



WARNING

Disconnect power before servicing the range. Replace all panels before operating range. Failure to do so can result in death or electrical shock.



WARNING

EXPLOSION, FIRE, AND ASPHYXIATION HAZARD

Shut off gas supply to the range before servicing. Check all gas lines and fittings for leaks before operating the range. Replace all panels before operating range. Failure to do so can result in death or personal injury from explosion, fire, or asphyxiation.



CAUTION

When you work on the gas range, be careful when handling sheet metal parts. Sharp edges may be present, and you can cut yourself if you are not careful.

3. Disassembly and Reassembly

Parts	Explanation Photo	Explanation
<p>ASSY FRAME COOKTOP</p>	 <p>The 'Explanation Photo' section contains several images: 1. A top-down view of the cooktop grates with red arrows pointing to the 'Cover Air' and 'Assy Grate'. 2. A close-up of a burner electrode with a red circle around it, labeled 'Electrode'. 3. A red arrow pointing downwards. 4. A view of the cooktop frame with the grates removed. 5. A collection of disassembled burner parts, including burner heads and burner caps, labeled 'Burner Head' and 'Burner Cap'.</p>	<ol style="list-style-type: none"> 1. Turn off the electrical supply going to the range. 2. Shut off the valve in the gas supply line to the range. 3. Lift off 2 Assy Grates 4. Lift off 5 burner caps & 4 heads from the burner cup and mid-heads.

3. Disassembly and Reassembly

Parts	Explanation Photo	Explanation
<p>ASSY FRAME COOKTOP</p>		<p>5. Remove 6 screws from the Burner mid-head & 3 screws from Burner cup.</p> <p>6. Take off the electrode wire from the Burner mid-head</p>

3. Disassembly and Reassembly

Parts	Explanation Photo	Explanation
<p>ASSY FRAME COOKTOP</p>		<p>7. Remove 4 screws from the Left/Right Chassis 8. Remove 3 screws from the Rear Chassis 9. Remove 3 screws from the Control Chassis 10. Remove 8 screws from the back of Cooktop and take off Assy Cover Air & Left/Right/Rear Chassis</p>
		<p>11. Remove 4 screws from Assy Frame cooktop 12. Take off the Assy Frame cooktop</p> <div data-bbox="950 1549 1458 1690" style="border: 1px solid gray; padding: 5px;"> <p>Note Make sure the electrodes are placed under the openings of Cooktop to prevent interference and damage during replacement.</p> </div>

3. Disassembly and Reassembly

3-1-4 (Step D) - Oven Door



WARNING

Disconnect power before servicing the range. Replace all panels before operating range. Failure to do so can result in death or electrical shock.



WARNING



The door is very heavy. Be careful when removing door. Do not lift door by the door handle.



CAUTION

When you work on the gas range, be careful when handling sheet metal parts. Sharp edges may be present, and you can cut yourself if you are not careful.

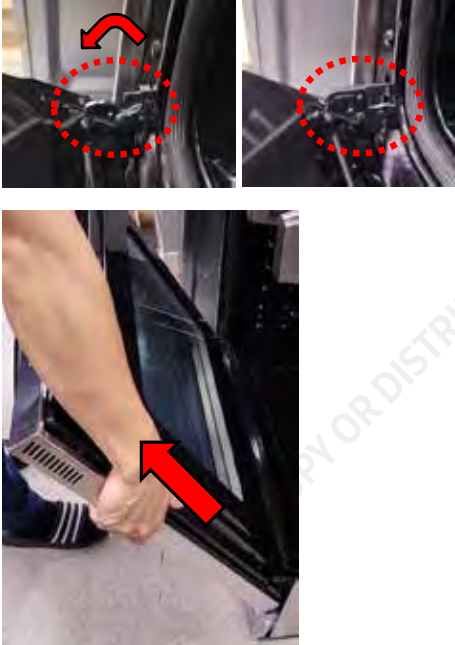
3. Disassembly and Reassembly

Parts	Explanation Photo	Explanation
OVEN DOOR		<p>To remove Oven Door:</p> <ol style="list-style-type: none"> 1. Fully open the door 2. Pull the hinge locks downward (use pliers) 3. Firmly grasp both side of the door at the top. 4. Close door to the door removal position, which is approximately 5 degrees. Lift door up and out until the hinge arm are clear of the slot.
		<p>To replace door:</p> <ol style="list-style-type: none"> 1. Firmly grasp both sides of the door at the top position and insert hinges into slots 2. Fully open the door. (If the door will not fully open, it means that the indentation is not seated correctly in the bottom edge of the slot. Push the hinge locks up to the locked position.) 3. Close the oven door.

3. Disassembly and Reassembly

3-1-5 (Step E) - Side Panel

⚠ WARNING

Disconnect power before servicing the range. Replace all panels before operating range. Failure to do so can result in death or electrical shock.

⚠ CAUTION

When you work on the gas range, be careful when handling sheet metal parts. Sharp edges may be present, and you can cut yourself if you are not careful.

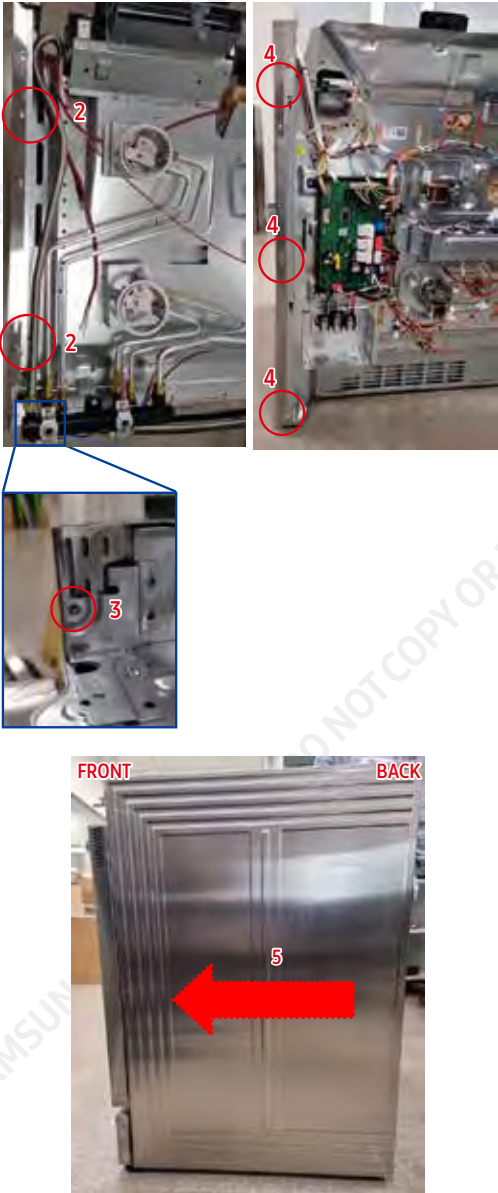
Parts	Explanation Photo	Explanation
<p>Side Panel</p>	<p>Left and Right is symmetric</p> 	<ol style="list-style-type: none"> 1. Follow the Step A, B and C. 2. Remove 4 screws from top side of Side Panel. 3. Remove 2 screws from left and right side of Side Panel. 4. Remove 6 screws from back side of Side Panel. 5. Pull forward the Side Panel from the range..

3. Disassembly and Reassembly

3-1-6 (Step F) – ASSY COOKTOP BURNER

⚠ WARNING

Disconnect power before servicing the range. Replace all panels before operating range. Failure to do so can result in death or electrical shock.

⚠ WARNING

EXPLOSION, FIRE, AND ASPHYXIATION HAZARD

Shut off gas supply to the range before servicing. Check all gas lines and fittings for leaks before operating the range. Replace all panels before operating range. Failure to do so can result in death or personal injury from explosion, fire, or asphyxiation.

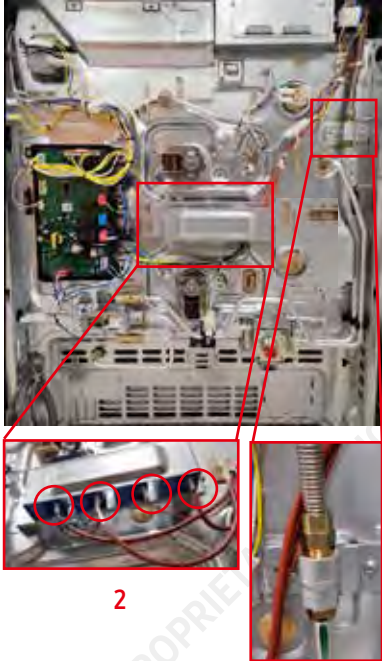
Parts	Explanation Photo	Explanation
<p>Assy Cooktop Burner</p>		<ol style="list-style-type: none"> 1. Follow the Step A, B and C. 2. Unplug Electrode wire from Module spark 3. Disconnect 1 flexible tube.

3. Disassembly and Reassembly

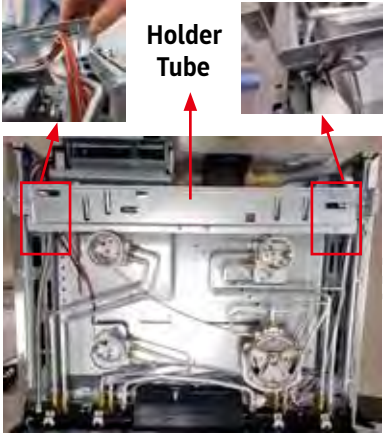
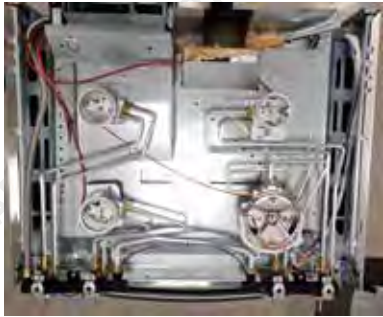
Parts	Explanation Photo	Explanation
<p>Assy Cooktop Burner</p>	 <p style="text-align: center;">Holder Tube</p>	<p>4. Release wire from Holder Tube 5. Take off Holder Tube .</p>
	 <p style="text-align: center;">Assy Cooktop Burner</p>	<p>6. Remove the Assy Cooktop Burner</p>

3. Disassembly and Reassembly

3-1-7 (Step G) – ASSY DRAWER

⚠ WARNING

Disconnect power before servicing the range. Replace all panels before operating range. Failure to do so can result in death or electrical shock.

⚠ WARNING

EXPLOSION, FIRE, AND ASPHYXIATION HAZARD

Shut off gas supply to the range before servicing. Check all gas lines and fittings for leaks before operating the range. Replace all panels before operating range. Failure to do so can result in death or personal injury from explosion, fire, or asphyxiation.

Parts	Explanation Photo	Explanation
<p>ASSY DRAWER</p>		<ol style="list-style-type: none"> 1. Open the ASSY DRAWER 2. Raise the plastic(right side) and drop the plastic(Left side) 3. Pull out the ASSY DARWER

3. Disassembly and Reassembly

3-2 Component replacement Step

3-2-1 MAIN PCB ASSEMBLY

⚠ WARNING

Disconnect power before servicing the range. Replace all panels before operating range. Failure to do so can result in death or electrical shock.

⚠ WARNING

EXPLOSION, FIRE, AND ASPHYXIATION HAZARD

Shut off gas supply to the range before servicing. Check all gas lines and fittings for leaks before operating the range. Replace all panels before operating range. Failure to do so can result in death or personal injury from explosion, fire, or asphyxiation.

⚠ CAUTION

When you work on the gas range, be careful when handling sheet metal parts. Sharp edges may be present, and you can cut yourself if you are not careful.

Parts	Explanation Photo	Explanation
<p>MAIN PCB ASSEMBLY</p>	 <p>MAIN PBA</p>	<ol style="list-style-type: none"> 1. Follow the step A. 2. Disconnect 8 wire connectors from the Main PCB. 3. Remove 2 screw of PCB assembly and replace the PCB.

3. Disassembly and Reassembly

PCB-SUB

! WARNING

Disconnect power before servicing the range. Replace all panels before operating range. Failure to do so can result in death or electrical shock.

! WARNING

EXPLOSION, FIRE, AND ASPHYXIATION HAZARD

Shut off gas supply to the range before servicing. Check all gas lines and fittings for leaks before operating the range. Replace all panels before operating range. Failure to do so can result in death or personal injury from explosion, fire, or asphyxiation.

! CAUTION

When you work on the gas range, be careful when handling sheet metal parts. Sharp edges may be present, and you can cut yourself if you are not careful.

Parts	Explanation Photo	Explanation
PCB-SUB		<ol style="list-style-type: none"> 1. Follow the Step B. 2. Remove 2 screw and COVER PCB-SUB. 3. Disconnect 6 wire connector from the PCB. 4. Remove 4 screw and HOLDE PCB-SUB. 5. Remove 1 screw and Replace the PCB-SUB (Fixed with 1 hooks)

3. Disassembly and Reassembly

PCB-Bluetooth

⚠ WARNING

Disconnect power before servicing the range. Replace all panels before operating range. Failure to do so can result in death or electrical shock.

⚠ WARNING

EXPLOSION, FIRE, AND ASPHYXIATION HAZARD

Shut off gas supply to the range before servicing. Check all gas lines and fittings for leaks before operating the range. Replace all panels before operating range. Failure to do so can result in death or personal injury from explosion, fire, or asphyxiation.

⚠ CAUTION

When you work on the gas range, be careful when handling sheet metal parts. Sharp edges may be present, and you can cut yourself if you are not careful.

Parts	Explanation Photo	Explanation
PCB-Bluetooth		<ol style="list-style-type: none"> 1. Follow the Step B. 2. Remove 2 screw and COVER PCB-SUB. 3. Disconnect 6 wire connector from the PCB. 4. Remove 4 screw and HOLDE PCB-SUB. 5. Replace the PCB-Bluetooth (Fixed with 1 hooks)

3. Disassembly and Reassembly

PCB-WiFi

⚠ WARNING

Disconnect power before servicing the range. Replace all panels before operating range. Failure to do so can result in death or electrical shock.

⚠ WARNING

EXPLOSION, FIRE, AND ASPHYXIATION HAZARD

Shut off gas supply to the range before servicing. Check all gas lines and fittings for leaks before operating the range. Replace all panels before operating range. Failure to do so can result in death or personal injury from explosion, fire, or asphyxiation.

⚠ CAUTION

When you work on the gas range, be careful when handling sheet metal parts. Sharp edges may be present, and you can cut yourself if you are not careful.

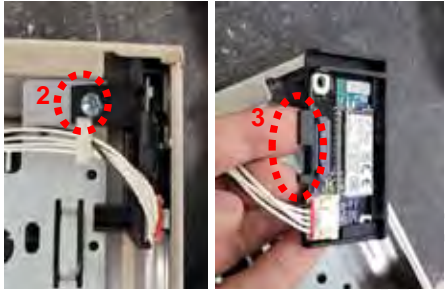
Parts	Explanation Photo	Explanation
PCB-WiFi		<ol style="list-style-type: none"> 1. Follow the Step B. 2. Remove 1 screw and HOLDER PCB-WiFi. 3. Replace the PCB-Bluetooth (Fixed with 1 hooks)

3. Disassembly and Reassembly

3-2-2 ASSY DISPLAY MODULE



WARNING

Disconnect power before servicing the range. Replace all panels before operating range. Failure to do so can result in death or electrical shock.



WARNING

EXPLOSION, FIRE, AND ASPHYXIATION HAZARD

Shut off gas supply to the range before servicing. Check all gas lines and fittings for leaks before operating the range. Replace all panels before operating range. Failure to do so can result in death or personal injury from explosion, fire, or asphyxiation.



CAUTION

When you work on the gas range, be careful when handling sheet metal parts. Sharp edges may be present, and you can cut yourself if you are not careful.

3. Disassembly and Reassembly

Parts	Explanation Photo	Explanation
<p>ASSY DISPLAY MODULE</p>		<ol style="list-style-type: none"> 1. Follow the Step B. 2. Remove 2 screw and COVER PCB-SUB. 3. Disconnect 6 wire connector from the PCB. 4. Remove 4 screw and HOLDE PCB-SUB. 5. Disconnect 1 wire connector from the ASSY DISPLAY MODULE. 6. Remove 4 screw and ASSY DISPLAY MODULE. 7. Replace ASSY DISPLAY MODULE.

3. Disassembly and Reassembly

3-2-3 ASSY MODE S/W & ASSY TEMPS/W

! WARNING

Disconnect power before servicing the range. Replace all panels before operating range. Failure to do so can result in death or electrical shock.

! WARNING

EXPLOSION, FIRE, AND ASPHYXIATION HAZARD

Shut off gas supply to the range before servicing. Check all gas lines and fittings for leaks before operating the range. Replace all panels before operating range. Failure to do so can result in death or personal injury from explosion, fire, or asphyxiation.

! CAUTION

When you work on the gas range, be careful when handling sheet metal parts. Sharp edges may be present, and you can cut yourself if you are not careful.

Parts	Explanation Photo	Explanation
<p>ASSY MODE S/W & ASSY TEMPS/W</p>		<ol style="list-style-type: none"> 1. Follow the Step B. 2. Remove 2 screw from the front of Control Box. (Left : Mode S/W , Right : Temp S/W) 3. Disconnect 3 wire connector from the Mode S/W. Disconnect 3 wire connector from the Temp S/W. 4. Push it to the right and pull it out. 5. Replace the each S/W

3. Disassembly and Reassembly

3-2-4 KNOB LED PCB

⚠ WARNING

Disconnect power before servicing the range. Replace all panels before operating range. Failure to do so can result in death or electrical shock.

⚠ WARNING

EXPLOSION, FIRE, AND ASPHYXIATION HAZARD

Shut off gas supply to the range before servicing. Check all gas lines and fittings for leaks before operating the range. Replace all panels before operating range. Failure to do so can result in death or personal injury from explosion, fire, or asphyxiation.

⚠ CAUTION

When you work on the gas range, be careful when handling sheet metal parts. Sharp edges may be present, and you can cut yourself if you are not careful.

Parts	Explanation Photo	Explanation
<p>KNOB LED PCB</p>		<ol style="list-style-type: none"> 1. Pull the knob out each valve. 2. Remove 2 screw from each HOLDER. 3. Disconnect 1 wire connector form KNOB LED SUB. 4. Remove HOLDER LED as Hook Bending. 5. Replace KNOB LED-SUB

3. Disassembly and Reassembly

3-2-5 ELECTRODE



WARNING

Disconnect power before servicing the range. Replace all panels before operating range. Failure to do so can result in death or electrical shock.



WARNING

EXPLOSION, FIRE, AND ASPHYXIATION HAZARD

Shut off gas supply to the range before servicing. Check all gas lines and fittings for leaks before operating the range. Replace all panels before operating range. Failure to do so can result in death or personal injury from explosion, fire, or asphyxiation.



CAUTION

When you work on the gas range, be careful when handling sheet metal parts. Sharp edges may be present, and you can cut yourself if you are not careful.



CAUTION

If replacing more than one burner cup, do not mix up the gas orifices. Incorrectly sized orifices could result in personal injury, fire, and/or poor cooking results.

3. Disassembly and Reassembly

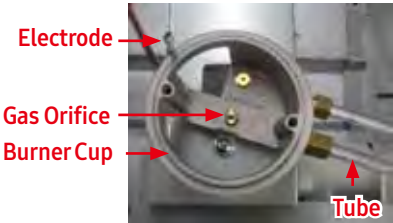
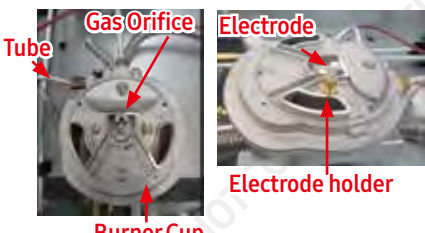
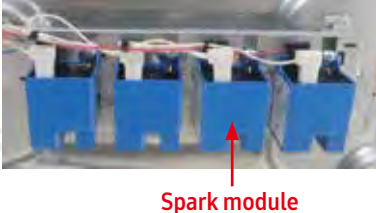
Parts	Explanation Photo	Explanation
ELECTRODE	<p style="text-align: center;">[Stack Burner]</p>  <p style="text-align: center;">[Dual Burner]</p>  	<p>1. Follow the Step A and C.</p> <p>2-1) (Stack burner) Disconnect wire connectors from the terminal on the spark module.</p> <p>2-2) (Dual burner) Carefully rotate electrode holder and pull it out from the bottom of the electrodes on the burner cups. Lift and slide the electrode wire out of the slot on the burner cup.</p>

3. Disassembly and Reassembly

3-2-6 BURNER CUP



WARNING

Disconnect power before servicing the range. Replace all panels before operating range. Failure to do so can result in death or electrical shock.



WARNING

EXPLOSION, FIRE, AND ASPHYXIATION HAZARD

Shut off gas supply to the range before servicing. Check all gas lines and fittings for leaks before operating the range. Replace all panels before operating range. Failure to do so can result in death or personal injury from explosion, fire, or asphyxiation.



CAUTION



When you work on the gas range, be careful when handling sheet metal parts. Sharp edges may be present, and you can cut yourself if you are not careful.



CAUTION

If replacing more than one burner cup, do not mix up the gas orifices. Incorrectly sized orifices could result in personal injury, fire, and/or poor cooking results.

3. Disassembly and Reassembly

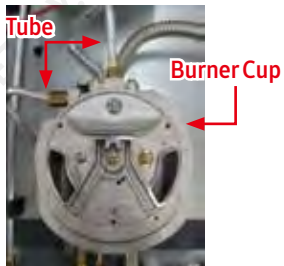
Parts	Explanation Photo	Explanation
<p>BURNER CUP</p>	<p>[Single : Rapid type]</p>  <p>[Single : Semi-Rapid type]</p>  <p>[Double]</p> 	<ol style="list-style-type: none"> 1. Follow the Step A and C. 2. Using a tubing wrench on the gas line fitting and a channel lock wrench on the burner cup base, firmly hold the cup base in place while disconnecting the gas line. 3. (Single type only) Remove 2 screws for each burner cup. 4. The burner cup can be removed. Replace it. <div style="border: 1px solid gray; padding: 5px; margin-top: 10px;"> <p>Note</p> <ul style="list-style-type: none"> • The new burner cup must be replaced with the same size as the one removed. </div> <ol style="list-style-type: none"> 5. After replacement, You must check gas leakage.

3. Disassembly and Reassembly

3-2-7 GAS ORIFICE NOZZLE (Stack Burner)

⚠ WARNING

Disconnect power before servicing the range. Replace all panels before operating range. Failure to do so can result in death or electrical shock.

⚠ WARNING

EXPLOSION, FIRE, AND ASPHYXIATION HAZARD

Shut off gas supply to the range before servicing. Check all gas lines and fittings for leaks before operating the range. Replace all panels before operating range. Failure to do so can result in death or personal injury from explosion, fire, or asphyxiation.

⚠ CAUTION

When you work on the gas range, be careful when handling sheet metal parts. Sharp edges may be present, and you can cut yourself if you are not careful.

⚠ CAUTION

If replacing more than one burner cup, do not mix up the gas orifices. Incorrectly sized orifices could result in personal injury, fire, and/or poor cooking results.

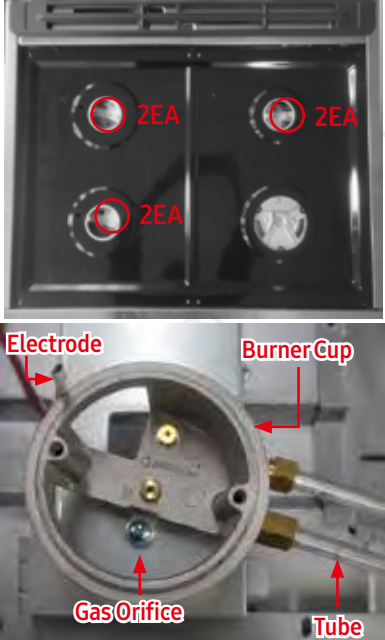
Parts	Explanation Photo	Explanation
<p>GAS ORIFICE NOZZLE (Stack Burner)</p>		<ol style="list-style-type: none"> 1. Lift off the cooktop burner caps and the cooktop burner heads from the cooktop burner manifold cups. 2. Using a 9/32-inch socket wrench or 7mm nut driver, remove the burner orifice from the bottom of each burner manifold cup. 3. Install a new gas orifice to the burner cup.

3. Disassembly and Reassembly

3-2-8 GAS ORIFICE NOZZLE (Dual Burner)

⚠ WARNING

Disconnect power before servicing the range. Replace all panels before operating range. Failure to do so can result in death or electrical shock.

⚠ WARNING

EXPLOSION, FIRE, AND ASPHYXIATION HAZARD

Shut off gas supply to the range before servicing. Check all gas lines and fittings for leaks before operating the range. Replace all panels before operating range. Failure to do so can result in death or personal injury from explosion, fire, or asphyxiation.

⚠ CAUTION

When you work on the gas range, be careful when handling sheet metal parts. Sharp edges may be present, and you can cut yourself if you are not careful.

⚠ CAUTION

If replacing more than one burner cup, do not mix up the gas orifices. Incorrectly sized orifices could result in personal injury, fire, and/or poor cooking results.

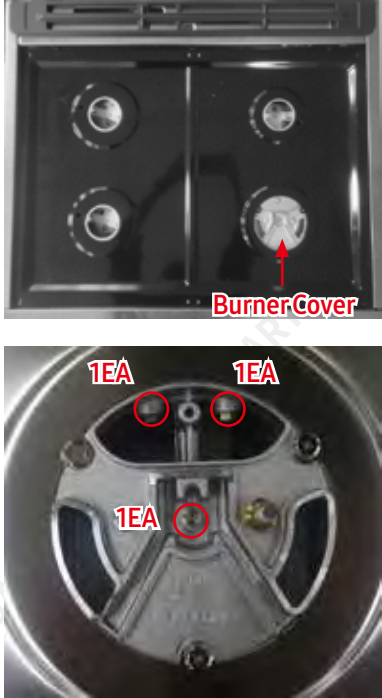
Parts	Explanation Photo	Explanation
<p>GAS ORIFICE NOZZLE (Dual Burner)</p>		<ol style="list-style-type: none"> 1. Remove screw on burner cover using screw driver. 2. Remove burner cover. 3. Remove 2 orifices using 9/32-inch socket wrench. 4. Install new two gas orifice to the burner cup and burner cover. 5. Remove 1 orifice on middle of burner using 9/32-inch socket wrench. 6. Install a new gas orifice to the burner cup

3. Disassembly and Reassembly

3-2-9 VALVE COOKTOP

⚠ WARNING

Disconnect power before servicing the range. Replace all panels before operating range. Failure to do so can result in death or electrical shock.

⚠ WARNING

EXPLOSION, FIRE, AND ASPHYXIATION HAZARD

Shut off gas supply to the range before servicing. Check all gas lines and fittings for leaks before operating the range. Replace all panels before operating range. Failure to do so can result in death or personal injury from explosion, fire, or asphyxiation.

⚠ CAUTION

When you work on the gas range, be careful when handling sheet metal parts. Sharp edges may be present, and you can cut yourself if you are not careful.

⚠ CAUTION

If replacing more than one burner cup, do not mix up the gas orifices. Incorrectly sized orifices could result in personal injury, fire, and/or poor cooking results.

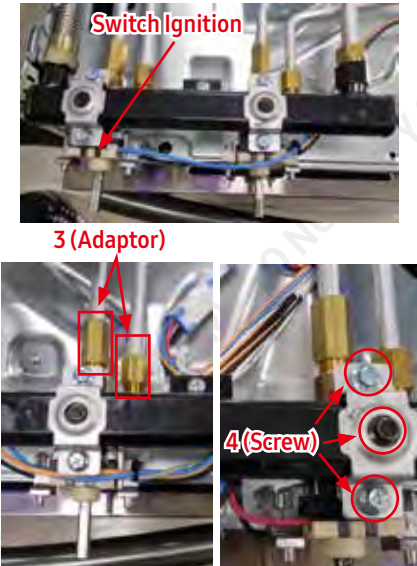
Parts	Explanation Photo	Explanation
VALVE COOKTOP		<ol style="list-style-type: none"> 1. Follow the Step B and C,F. 2. Place a finger behind each side of the switch ignition and pull it straight out to release it from the control shaft. 3. Using a tubing wrench and a channel lock wrench, disconnect the gas lines from the valve cooktop. Do not bend or crimp gas lines during Removal. 4. Remove the Valve Cooktop followed by removal of 3 screw on the valve cooktop. 5. Replace the Valve Cooktop and Check gas leakage. <div style="border: 1px solid gray; padding: 5px; margin-top: 10px;"> <p>Note</p> <ul style="list-style-type: none"> • When assembling or disassembling the valve, the screw torque should be adjusted to 1.5N.m. </div>

3. Disassembly and Reassembly

3-2-10 SWITCH IGNITION

⚠ WARNING

Disconnect power before servicing the range. Replace all panels before operating range. Failure to do so can result in death or electrical shock.

⚠ WARNING

EXPLOSION, FIRE, AND ASPHYXIATION HAZARD

Shut off gas supply to the range before servicing. Check all gas lines and fittings for leaks before operating the range. Replace all panels before operating range. Failure to do so can result in death or personal injury from explosion, fire, or asphyxiation.

⚠ CAUTION

When you work on the gas range, be careful when handling sheet metal parts. Sharp edges may be present, and you can cut yourself if you are not careful.

⚠ CAUTION

If replacing more than one burner cup, do not mix up the gas orifices. Incorrectly sized orifices could result in personal injury, fire, and/or poor cooking results.

Parts	Explanation Photo	Explanation
SWITCH IGNITION		<ol style="list-style-type: none"> 1. Follow the Step B 2. Place a finger behind each side of the switch ignition and pull it straight out to release it from the control shaft. Repeat this step to all switches. 3. Disconnect the wires from the connectors. 4. Bend the Clamp for disconnecting the Wire of Switch Ignition. 5. Replace the Switch Ignition.

3. Disassembly and Reassembly

3-2-11 ASSY MOTOR

⚠ WARNING

Disconnect power before servicing the range. Replace all panels before operating range. Failure to do so can result in death or electrical shock.

⚠ WARNING

EXPLOSION, FIRE, AND ASPHYXIATION HAZARD

Shut off gas supply to the range before servicing. Check all gas lines and fittings for leaks before operating the range. Replace all panels before operating range. Failure to do so can result in death or personal injury from explosion, fire, or asphyxiation.

⚠ CAUTION

When you work on the gas range, be careful when handling sheet metal parts. Sharp edges may be present, and you can cut yourself if you are not careful.

⚠ CAUTION

Check the parts code of the knob and/or Switch Ignition in case of replacement.

Parts	Explanation Photo	Explanation
<p>ASSY MOTOR</p>	 <p style="text-align: center;">ASSY MOTOR</p>	<ol style="list-style-type: none"> 1. Follow the Step A and C. 2. Remove 3 screws from Cover back main and Cover adiabatic-top. 3. Disconnect 1 terminal housing from the Assy Motor and Main Wire.

3. Disassembly and Reassembly

3-2-12 ASSY DOOR LATCH

⚠ WARNING

Disconnect power before servicing the range. Replace all panels before operating range. Failure to do so can result in death or electrical shock.

⚠ WARNING

EXPLOSION, FIRE, AND ASPHYXIATION HAZARD

Shut off gas supply to the range before servicing. Check all gas lines and fittings for leaks before operating the range. Replace all panels before operating range. Failure to do so can result in death or personal injury from explosion, fire, or asphyxiation.

⚠ CAUTION

When you work on the gas range, be careful when handling sheet metal parts. Sharp edges may be present, and you can cut yourself if you are not careful.

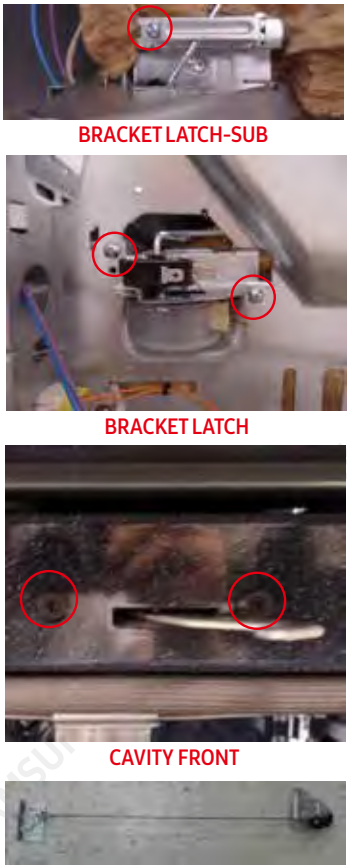
Parts	Explanation Photo	Explanation
<p>ASSY DOOR LATCH</p>	 <p>BRACKET LATCH-SUB</p> <p>BRACKET LATCH</p> <p>CAVITY FRONT</p> <p>ASSY BRACKET LATCH</p>	<ol style="list-style-type: none"> 1. Follow the Step E. 2. Remove 2 screws from the Cavity Front. 3. Remove 1 screw from the Bracket-Latch sub to the rear of the range. 4. Disconnect wires of the door latch to the rear of the range and remove it. 5. Remove 2 screws holding the Assy bracket-latch rear to the rear of the range. 6. Replace the Assy Bracket Latch. 7. Test the Assy Door Latch to make sure it is latching and unlatching properly.

3. Disassembly and Reassembly

3-2-13 SWITCH-DOOR PLUNGER

⚠ WARNING

Disconnect power before servicing the range. Replace all panels before operating range. Failure to do so can result in death or electrical shock.

⚠ WARNING

EXPLOSION, FIRE, AND ASPHYXIATION HAZARD

Shut off gas supply to the range before servicing. Check all gas lines and fittings for leaks before operating the range. Replace all panels before operating range. Failure to do so can result in death or personal injury from explosion, fire, or asphyxiation.

⚠ CAUTION

When you work on the gas range, be careful when handling sheet metal parts. Sharp edges may be present, and you can cut yourself if you are not careful.

Parts	Explanation Photo	Explanation
<p>SWITCH-DOOR PLUNGER</p>		<ol style="list-style-type: none"> 1. Turn off the electrical supply going to the range. 2. Shut off the gas shut-off valve in the gas supply line to the range. 3. Open the oven door. 4. Carefully pull out the switch door plunger switch from the upper left corner of the cavity front. Gently grasp the plunger with pliers and work from side to side while pulling. Pull out far enough to expose the wires. 5. Note the location and mark the wires; then disconnect the wire to the switch door plunger. 6. Replace with the switch-door plunger, re-connect the wires in their original positions, and reinstall switch in the oven frame.

3. Disassembly and Reassembly

3-2-14 ASSY LAMP

⚠ WARNING

Disconnect power before servicing the range. Replace all panels before operating range. Failure to do so can result in death or electrical shock.

⚠ WARNING

EXPLOSION, FIRE, AND ASPHYXIATION HAZARD

Shut off gas supply to the range before servicing. Check all gas lines and fittings for leaks before operating the range. Replace all panels before operating range. Failure to do so can result in death or personal injury from explosion, fire, or asphyxiation.

⚠ CAUTION

When you work on the gas range, be careful when handling sheet metal parts. Sharp edges may be present, and you can cut yourself if you are not careful.

Parts	Explanation Photo	Explanation
<p>ASSY LAMP</p>		<ol style="list-style-type: none"> 1. Open the oven door and remove the racks from inside the oven. 2. There is 1 Lamps which located in Left-Upper side. Turn oven lamp cover counterclockwise to loosen and remove the cover. 3. Remove the oven light bulb. 4. After replacement, Install Oven light cover by turning clockwise.

3. Disassembly and Reassembly

3-2-15 SENSOR-THERMISTER

⚠ WARNING

Disconnect power before servicing the range. Replace all panels before operating range. Failure to do so can result in death or electrical shock.

⚠ WARNING

EXPLOSION, FIRE, AND ASPHYXIATION HAZARD

Shut off gas supply to the range before servicing. Check all gas lines and fittings for leaks before operating the range. Replace all panels before operating range. Failure to do so can result in death or personal injury from explosion, fire, or asphyxiation.

⚠ CAUTION

When you work on the gas range, be careful when handling sheet metal parts. Sharp edges may be present, and you can cut yourself if you are not careful.

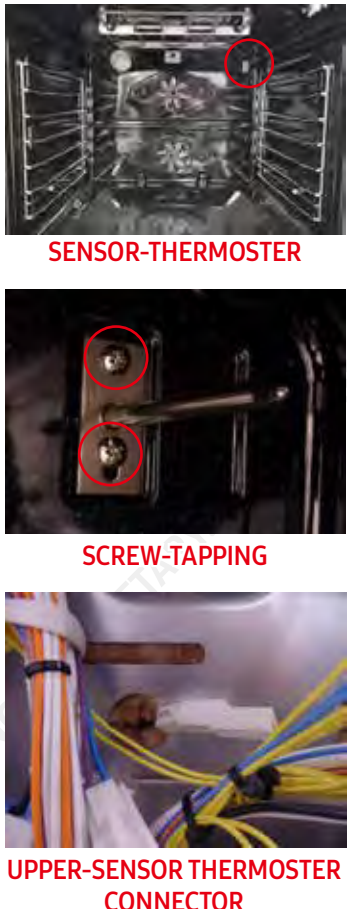
Parts	Explanation Photo	Explanation
<p>ASSY LAMP</p>	 <p>SENSOR-THERMISTER</p> <p>SCREW-TAPPING</p> <p>UPPER-SENSOR THERMISTER CONNECTOR</p>	<ol style="list-style-type: none"> Follow the Step A. Open the oven door and remove the racks from inside the oven. Disconnect connector of the sensor thermistor to the rear of the range. The oven sensor thermistor is in the upper right-hand corner of the oven cavity. Remove 2 screws and carefully pull the sensor wire leads until the wire connectors appear. Reverse the order to install the oven temperature sensor. <div style="border: 1px solid gray; padding: 5px; margin-top: 10px;"> <p>Note</p> <ul style="list-style-type: none"> If you can't access the wire connectors from inside the oven, remove the rear cover panel. Mark and disconnect the two wires going to the oven sensor thermistor. </div>

3. Disassembly and Reassembly

3-2-16 GASKET DOOR

⚠ WARNING

Disconnect power before servicing the range. Replace all panels before operating range. Failure to do so can result in death or electrical shock.

⚠ WARNING

EXPLOSION, FIRE, AND ASPHYXIATION HAZARD

Shut off gas supply to the range before servicing. Check all gas lines and fittings for leaks before operating the range. Replace all panels before operating range. Failure to do so can result in death or personal injury from explosion, fire, or asphyxiation.

⚠ CAUTION

When you work on the gas range, be careful when handling sheet metal parts. Sharp edges may be present, and you can cut yourself if you are not careful.

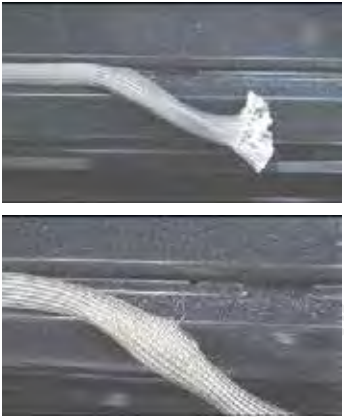
Parts	Explanation Photo	Explanation
<p>ASSY LAMP</p>		<ol style="list-style-type: none"> 1. Open the oven door to its fully down position. 2. Pull the ends of the gasket out of the liner holes. 3. Pull the oven door gasket clips out of the holes until all of the clips are removed. 4. When the service is complete, Insert gasket clips in each mounting hole. Push the ends of gasket in end holes in the bottom of the front oven frame. 5. Close the oven door. <div style="border: 1px solid red; padding: 5px; margin-top: 10px;"> <p>REASSEMBLY NOTE</p> <p>When you install the new gasket, make sure that all of the clips are seated in their liner holes, and that the ends of the gasket are pushed fully into their holes. Use the pointed end of a pencil to push the gasket ends into the holes.</p> </div>

3. Disassembly and Reassembly

3-2-17 HANDLE-DOOR, GLASS INNER

⚠ WARNING

Disconnect power before servicing the range. Replace all panels before operating range. Failure to do so can result in death or electrical shock.

⚠ WARNING

EXPLOSION, FIRE, AND ASPHYXIATION HAZARD





Shut off gas supply to the range before servicing. Check all gas lines and fittings for leaks before operating the range. Replace all panels before operating range. Failure to do so can result in death or personal injury from explosion, fire, or asphyxiation.

⚠ CAUTION



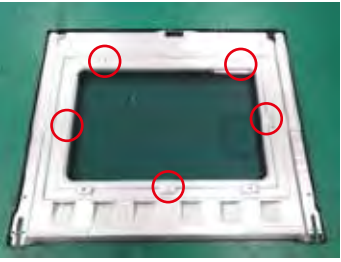
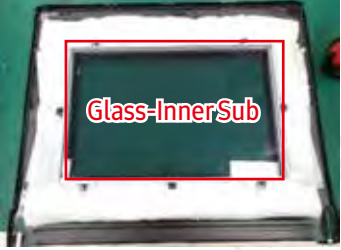

When you work on the gas range, be careful when handling sheet metal parts. Sharp edges may be present, and you can cut yourself if you are not careful.

Parts	Explanation Photo	Explanation
<p>HANDLE-DOOR, GLASS INNER</p>		<ol style="list-style-type: none"> 1. Remove Door from the oven 2. Remove two handle screws (top) and 3 screw-tapping (bottom), then separate Assy Door Sub <p>Put door down gently on padded surface as to not damage Chassis / Handle</p>

3. Disassembly and Reassembly

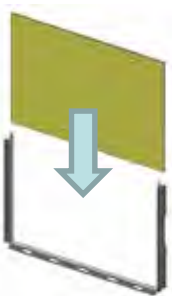
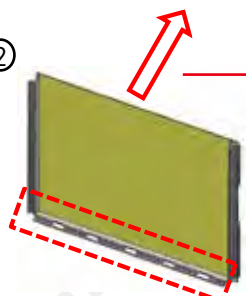
Parts	Explanation Photo	Explanation
<p>HANDLE-DOOR, GLASS INNER</p>	<p>① </p>	<p>To remove Handle-Door</p> <p>1. Remove 2 screws to remove Handle- Door</p> <p>To remove Glass-Inner (Up)</p> <p>1. Remove 6 screws to remove each Assy Hinge.</p> <p>2. Remove 2 screws to remove Glass-Sub</p> <p>3. Remove 5 screws to remove Baffle Door</p> <p>4. Remove Glass Inner Sub</p> <p>5. Disassemble Glass Inner Sub by unfolding flanges, then remove Glass Inner</p> <p>See next page for Glass Inner direction</p>
	<p>① </p>	
	<p>② </p>	
	<p>③ </p>	
	<p>④ </p>	
	<p>⑤ </p>	

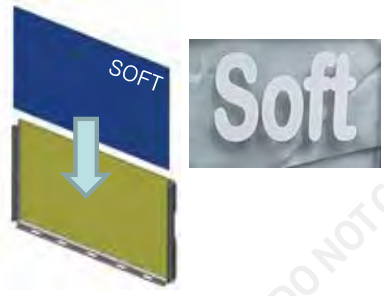
3. Disassembly and Reassembly

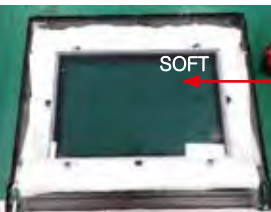
Parts	Explanation Photo	Explanation
<p>HANDLE-DOOR, GLASS INNER</p>	<p>① </p> <p>② </p> <p>5 Shorter Holes on this side (Away from coating side)</p> <div data-bbox="771 756 1096 1102" style="border: 1px solid red; padding: 5px;"> <p>Coating side this way</p> <p>Check with multimeter: Coating side: resistance <math>< 100\Omega</math> Non coating side: no value</p>  </div> <p>CHASSIS SIDE GLASS: "SOFT" PRINT Check with print. Do not check with multimeter</p> <p>③ </p> <p>④ </p> <p>⑤ </p> <p>Top right corner</p>	<p>GLASS INNER COATING DIRECTION: How to reassemble</p> <p>* When reassembling, make sure to clean adiabatic / stain on Glass Inner</p>

3. Disassembly and Reassembly

3-2-18 ASSY POWER CORD

⚠ WARNING

Disconnect power before servicing the range. Replace all panels before operating range. Failure to do so can result in death or electrical shock.

⚠ WARNING

EXPLOSION, FIRE, AND ASPHYXIATION HAZARD

Shut off gas supply to the range before servicing. Check all gas lines and fittings for leaks before operating the range. Replace all panels before operating range. Failure to do so can result in death or personal injury from explosion, fire, or asphyxiation.

⚠ CAUTION

When you work on the gas range, be careful when handling sheet metal parts. Sharp edges may be present, and you can cut yourself if you are not careful.

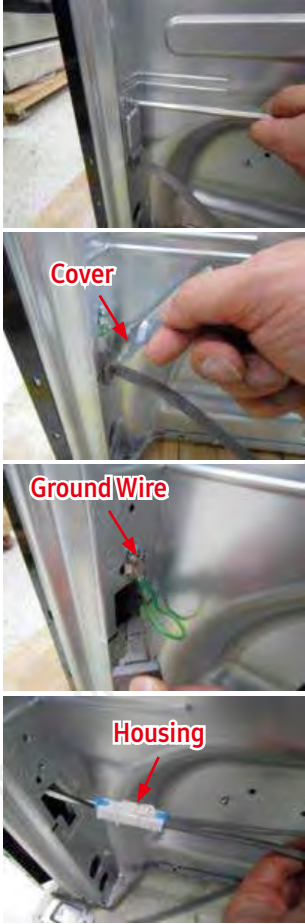
Parts	Explanation Photo	Explanation
<p>ASSY POWER CORD</p>		<ol style="list-style-type: none"> 1. Turn off the electrical supply going to the range. 2. Remove a screw of cover and pull it out from the range. 3. Remove a screw of the ground wire. 4. Pull on the power cord wire. 5. Disconnect the housing of the wire and replace it.

3. Disassembly and Reassembly

3-2-19 BURNER BROIL

⚠ WARNING

Disconnect power before servicing the range. Replace all panels before operating range. Failure to do so can result in death or electrical shock.

⚠ WARNING

EXPLOSION, FIRE, AND ASPHYXIATION HAZARD

Shut off gas supply to the range before servicing. Check all gas lines and fittings for leaks before operating the range. Replace all panels before operating range. Failure to do so can result in death or personal injury from explosion, fire, or asphyxiation.

⚠ CAUTION

When you work on the gas range, be careful when handling sheet metal parts. Sharp edges may be present, and you can cut yourself if you are not careful.

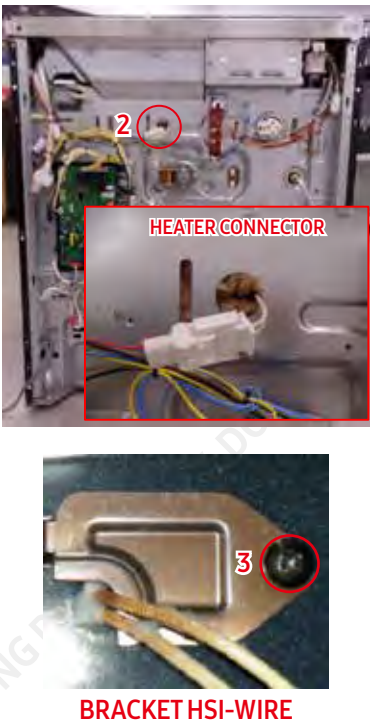
Parts	Explanation Photo	Explanation
<p>BURNER BROIL</p>		<ol style="list-style-type: none"> 1. Follow the step A. 2. Disconnect the connector of the HSI. (Identify and mark the two wires going to HSI.) 3. Remove 1 screw of bracket HSI-wire and separate the bracket HSI-wire.

3. Disassembly and Reassembly

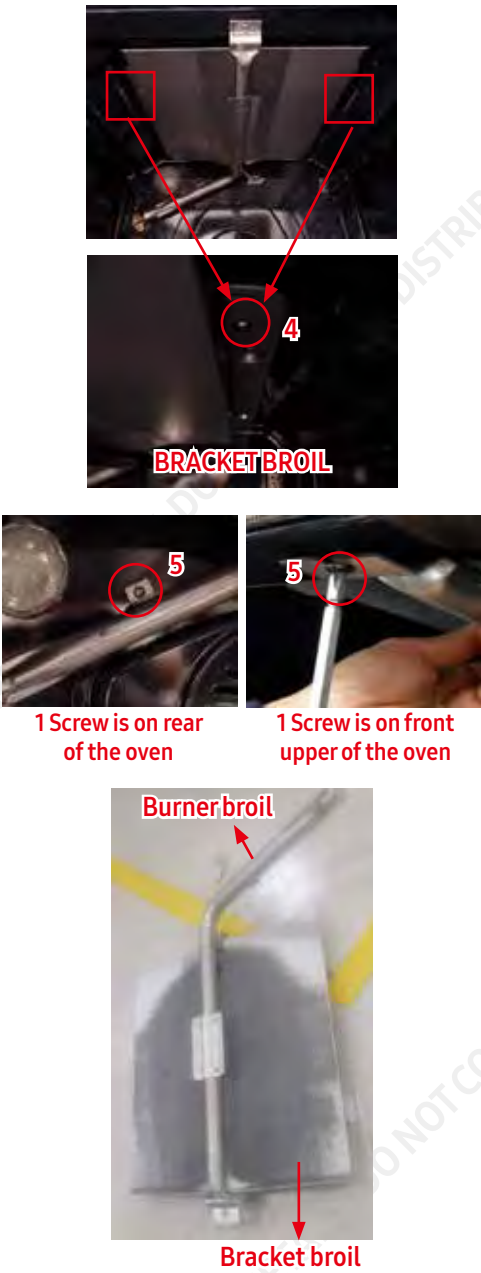
Parts	Explanation Photo	Explanation
<p>BURNER BROIL</p>	 <p>4</p> <p>BRACKET BROIL</p> <p>5</p> <p>5</p> <p>1 Screw is on rear of the oven</p> <p>1 Screw is on front upper of the oven</p> <p>Burner broil</p> <p>Bracket broil</p>	<p>4. Remove 2 screws of Bracket broil on front sides of Bracket broil.</p> <p>5. Supporting the Assy Bracket broil with one hand, remove 2 screws. (one is on the rear of the oven, other is on the front upper of oven)</p> <p>6. Carefully pull the Assy Bracket broil to separate it from Shied cavity and the holder nozzle-broil on the rear wall of the oven.</p> <p>7. Separate Burner broil from Bracket broil.</p>

3. Disassembly and Reassembly

3-2-20 HOT SURFACE IGNITOR (HSI) of the BURNER BROIL, NOZZLE BROIL, HOLDER NOZZLE BROIL

⚠ WARNING

Disconnect power before servicing the range. Replace all panels before operating range. Failure to do so can result in death or electrical shock.

⚠ WARNING

EXPLOSION, FIRE, AND ASPHYXIATION HAZARD

Shut off gas supply to the range before servicing. Check all gas lines and fittings for leaks before operating the range. Replace all panels before operating range. Failure to do so can result in death or personal injury from explosion, fire, or asphyxiation.

⚠ CAUTION

When you work on the gas range, be careful when handling sheet metal parts. Sharp edges may be present, and you can cut yourself if you are not careful.

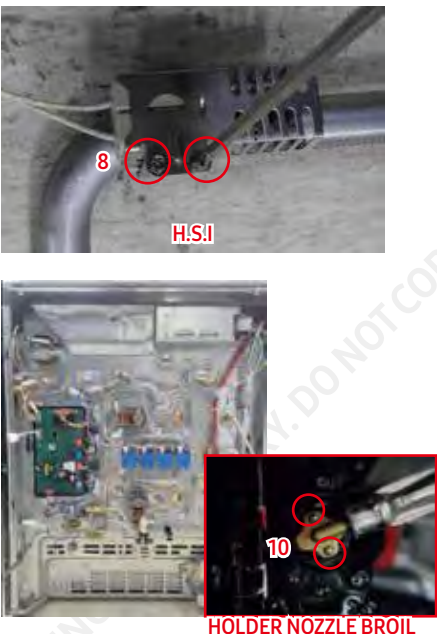
Parts	Explanation Photo	Explanation
<p>HOT SURFACE IGNITOR (HSI) of the BURNER BROIL, NOZZLE BROIL, HOLDER NOZZLE BROIL</p>	 <p>H.S.I</p> <p>HOLDER NOZZLE BROIL</p>	<p>Continued <i>BURNER BROIL</i> part.</p> <p>8. To replace the H.S.I of the burner broil, remove 2 screws assembled to H.S.I</p> <p>9. To replace the Holder nozzle broil, loose the nut of pipe from the back.</p> <p>10. To replace the Holder nozzle broil, remove 2 screws supporting the Holder nozzle broil on the rear of the oven.</p>

3. Disassembly and Reassembly

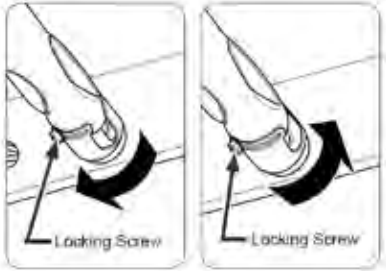
Parts	Explanation Photo	Explanation
<p>HOT SURFACE IGNITOR (HSI) of the BURNER BROIL, NOZZLE BROIL, HOLDER NOZZLE BROIL</p>	 <p>NOTE</p> 	<ol style="list-style-type: none"> 11. To replace the Nozzle broil, remove the gas nozzle with a 9/32-inch socket wrench 12. After service, assemble Nozzle, Holder nozzle broil, Burner broil and H.S.I in reverse order. <div style="border: 1px solid gray; padding: 5px; margin-top: 10px;"> <p>Note</p> <ul style="list-style-type: none"> The oven burner flames can be adjusted by loosening the locking screw and opening or closing the air shutter at the base of the oven burner. </div>

3. Disassembly and Reassembly

3-2-21 BURNER BAKE

! WARNING

Disconnect power before servicing the range. Replace all panels before operating range. Failure to do so can result in death or electrical shock.

! WARNING

EXPLOSION, FIRE, AND ASPHYXIATION HAZARD

Shut off gas supply to the range before servicing. Check all gas lines and fittings for leaks before operating the range. Replace all panels before operating range. Failure to do so can result in death or personal injury from explosion, fire, or asphyxiation.

! CAUTION

When you work on the gas range, be careful when handling sheet metal parts. Sharp edges may be present, and you can cut yourself if you are not careful.

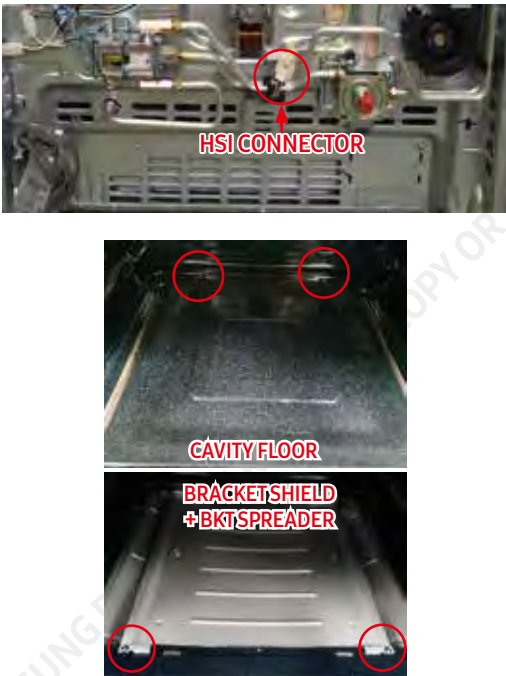
Parts	Explanation Photo	Explanation
<p>BURNER BAKE</p>	 <p>The first photo shows the HSI connector with a red circle and arrow. The second photo shows the cavity floor with two red circles. The third photo shows the bracket shield and bake spreader with two red circles.</p>	<ol style="list-style-type: none"> 1. Turn off the electrical supply going to the range. 2. Shut off the gas shut-off valve in the gas supply line to the range. 3. Open the oven door and remove the racks from inside the oven. 4. Pull on the wires or the connector until the wire connector appears from the back wall of the warming drawer opening. 5. Disconnect the connector of HSI of the burner bake. 6. Remove 2 screws from the back of the cavity floor. lift back to clear the front edge and lift out the cavity floor. 7. Remove 2 screws from the front of the bracket bake-spreader.

3. Disassembly and Reassembly

Parts	Explanation Photo	Explanation
<p>BURNER BAKE</p>	 <p>The 'Explanation Photo' column contains three images. The top image shows the burner bake being lifted from the broil sub, with red circles highlighting the connection points. The middle image shows the burner bake being lifted from the holder-bake burner, with red circles highlighting the connection points. The bottom image shows the burner bake with labels for 'BURNER BAKE' and 'HSI (Hot-Surface Igniter)'.</p>	<p>8. Lift front the bracket bake-spreader and lift out the bracket-bake spreader.</p> <p>9. Remove 1 screws from bracket broil sub and lift up the bracket broil sub .</p> <p>10. Remove 2 screws from the Burner Bake and lift up the burner bake from the holder-bake burner on the bottom of the drawer.</p>

3. Disassembly and Reassembly

3-2-22 HOT SURFACE IGNITOR (HSI) of the BURNER BAKE, NOZZLE BAKE-BURNER, HOLDER BAKE-BURNER

! WARNING

Disconnect power before servicing the range. Replace all panels before operating range. Failure to do so can result in death or electrical shock.

! WARNING

EXPLOSION, FIRE, AND ASPHYXIATION HAZARD

Shut off gas supply to the range before servicing. Check all gas lines and fittings for leaks before operating the range. Replace all panels before operating range. Failure to do so can result in death or personal injury from explosion, fire, or asphyxiation.

! CAUTION

When you work on the gas range, be careful when handling sheet metal parts. Sharp edges may be present, and you can cut yourself if you are not careful.

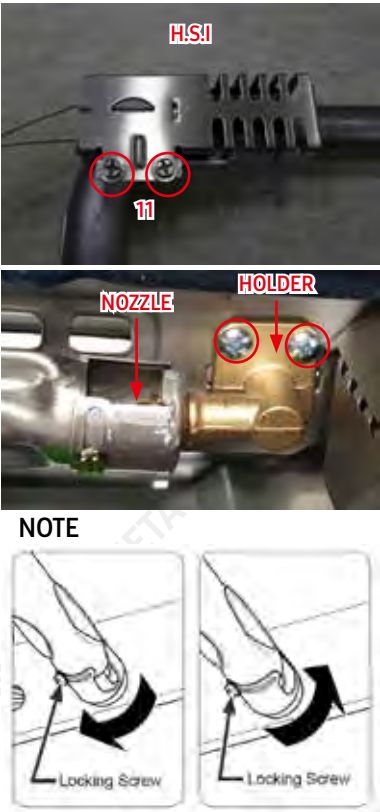
Parts	Explanation Photo	Explanation
<p>HOT SURFACE IGNITOR (HSI) of the BURNER BAKE</p> <p>NOZZLE BAKE-BURNER</p> <p>HOLDER BAKE-BURNER</p>	 <p>NOTE</p>	<p>11. To replace the H.S.I of the burner bake, remove 2 screws assembled to H.S.I</p> <p>12. To replace the nozzle bake-burner, remove the gas orifice with a 9/32-inch socket wrench.</p> <p>13. To remove the holder-bake burner, remove 2 screws supporting the holder-bake burner to the rear of the oven.</p> <p>14. When the service is complete, reverse the order to install Burner bake, H.S.I, Nozzle, Holder bake-burner</p> <div style="border: 1px solid gray; padding: 5px; margin-top: 10px;"> <p>Note</p> <ul style="list-style-type: none"> The oven burner flames can be adjusted by loosening the locking screw and opening or closing the air shutter at the base of the oven burner. </div>

3. Disassembly and Reassembly

3-2-23 ASSY VALVE SAFETY



WARNING

Disconnect power before servicing the range. Replace all panels before operating range. Failure to do so can result in death or electrical shock.



WARNING

EXPLOSION, FIRE, AND ASPHYXIATION HAZARD

Shut off gas supply to the range before servicing. Check all gas lines and fittings for leaks before operating the range. Replace all panels before operating range. Failure to do so can result in death or personal injury from explosion, fire, or asphyxiation.



CAUTION

When you work on the gas range, be careful when handling sheet metal parts. Sharp edges may be present, and you can cut yourself if you are not careful.

3. Disassembly and Reassembly

Parts	Explanation Photo	Explanation
<p>ASSY VALVE SAFETY</p>	 <p>SCREW-TAPPING - 4EA</p> <p>GAS PIPE - 3EA</p> <p>ASSY VALVE SAFETY</p>	<ol style="list-style-type: none"> 1. Turn off the electrical supply going to the range. 2. Shut off the gas shut-off valve in the gas supply line to the range. 3. Carefully identify and mark the wires going to the ASSY VALVE SAFETY. Disconnect the 4 wires <div style="border: 1px solid gray; padding: 5px; margin-bottom: 10px;"> <p>WARNING</p> <ul style="list-style-type: none"> Cross-wiring the wires to the ASSY VALVE SAFETY creates an explosion hazard that can result in death, personal injury, and/or property and product damage. </div> <ol style="list-style-type: none"> 4. Remove 4 screws from ASSY VALVE SAFETY. And disconnect the 3 Gas pipe using a tubing wrench and channel-lock wrench. (Do not bend or crimp gas pipe during removal.) 5. Install the new ASSY VALVE SAFETY with 4 screws. 6. Reconnect wire connectors in their original positions. <div style="border: 1px solid gray; padding: 5px; margin-bottom: 10px;"> <p>Note</p> <ul style="list-style-type: none"> Check all gas pipes and fittings for leaks before operation. </div> <div style="border: 1px solid gray; padding: 5px; margin-bottom: 10px;"> <p>WARNING</p> <ul style="list-style-type: none"> Cross-wiring the wires to the ASSY VALVE SAFETY creates an explosion hazard that can result in death, personal injury, and/or property and product damage. </div> <ol style="list-style-type: none"> 7. Reconnect All gas pipe to the ASSY VALVE TY.



3. Disassembly and Reassembly

3-2-24 SUPPORT RACK LEFT/RIGHT



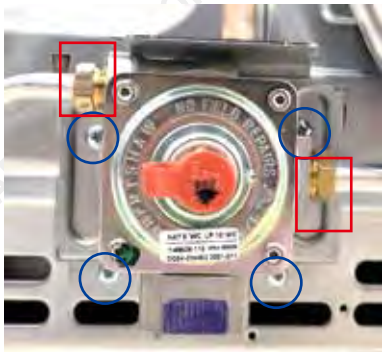

Parts	Explanation Photo	Explanation
<p>SUPPORT RACK LEFT/RIGHT</p>		<ol style="list-style-type: none"> 1. Open the oven door and remove the racks from inside the oven. 2. Push handle side to upward and take off from Holder Rack 2 Points. 3. Move slightly Upward and Pull out Pin of Rack from bracket 2points. 4. Left and Right side is symmetrical structure, Do following same process.

3. Disassembly and Reassembly

3-2-25 ASSY VALVE REGULATOR

Parts	Explanation Photo	Explanation
<p>ASSY VALVE REGULATOR</p>	 <p>— Explanation 3 — Explanation 4</p>  <p>Explanation 5</p>	<ol style="list-style-type: none"> 1. Turn off the electrical supply going to the range. 2. Shut off the gas shut-off valve in the gas supply line to the range. 3. Loosen 2 gas pipes that are connected with assy valve regulator. 4. Remove 4 screws from support regulator and pull assy valve regulator from assy cover back. 5. Remover 3 screws from back side of support regulator. 6-1. <ol style="list-style-type: none"> 1) If Customer's range with Old Version of Assy Cover Back, 2) If Support Regulator with Old Version #1, Old Version of Assy Valve Regulator Measures to be taken ; Replace Assy Valve Regulator with Old version. 6-2. <ol style="list-style-type: none"> 1) If Customer's range with Old Version of Assy Cover Back, 2) If Support Regulator with Old Version #2, New Version of Assy Valve Regulator Measures to be taken ; Replace Assy Valve Regulator with New version. 6-3. <ol style="list-style-type: none"> 1) If Customer's range with New Version of Assy Cover Back, 2) If Support Regulator with New Version, New Version of Assy Valve Regulator Measures to be taken ; Replace Assy Valve Regulator with New version. 7. Reassemble in reverse order of previous process. 8. After reassemble, open the shut-off valve on assy valve regulator.

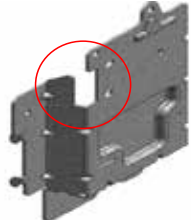
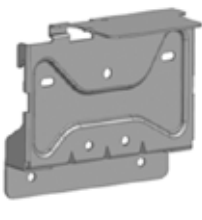
3. Disassembly and Reassembly

Parts	Explanation Photo		Explanation	
ASSY VALVE REGULATOR	Detailed Changing Points			
	Part	Old Version	New Version	
	Assy Valve Regulator			
		Code : DG94-01286A DG94-03445A DG94-03445B	Code : DG94-01286B DG94-03445C DG94-03445D	
	Part	Old Version #1	Old Version #2	New Version
Support Regulator				
	Code : DG61-01920A	Code : DG61-01920B	Code : DG61-02715A	
Part	Old Version		New Version	
Assy Cover Back				
	Code: DG63-00695A			

4. Troubleshooting

4-1 Failure Display Codes

There are two kinds of error codes. One denotes an oven temperature sensor error and the other denotes a safety error. Possible error codes during use can be checked before service.

1. Touch the 'Settings' key and Touch the 'Plus' and 'OK' to select 'Set time' menu.



2. Touch the 'Plus' and 'Minus' to set the time to 12:34.



3. Touch the 'OK' key to go to the home screen.



4. Push the 'Settings' and the 'Light' at the same time for 3 seconds. Error codes are displayed.



5. Touch the 'Plus' and 'Minus', to display the latest 5 error codes.



6. Turn the mode knob OFF to return to normal display mode.

4. Troubleshooting

Failure Display Codes

Information code	Meaning	SOLUTION
C-20	Oven sensor opened (over 2950Ω)	1. Disconnect power. Open the back cover. Disconnect sensor harness from control Measure sensor resistance :1080Ω at the room temperature → If there are any problems, replace oven sensor. 2. If there is not any problem with oven sensor, Please check whether there is a damaged terminal or wire harness. 3. Check resistance of oven sensor connector on main PCB (Normal:2850Ω)
	Oven sensor shorted. (Under 930Ω)	

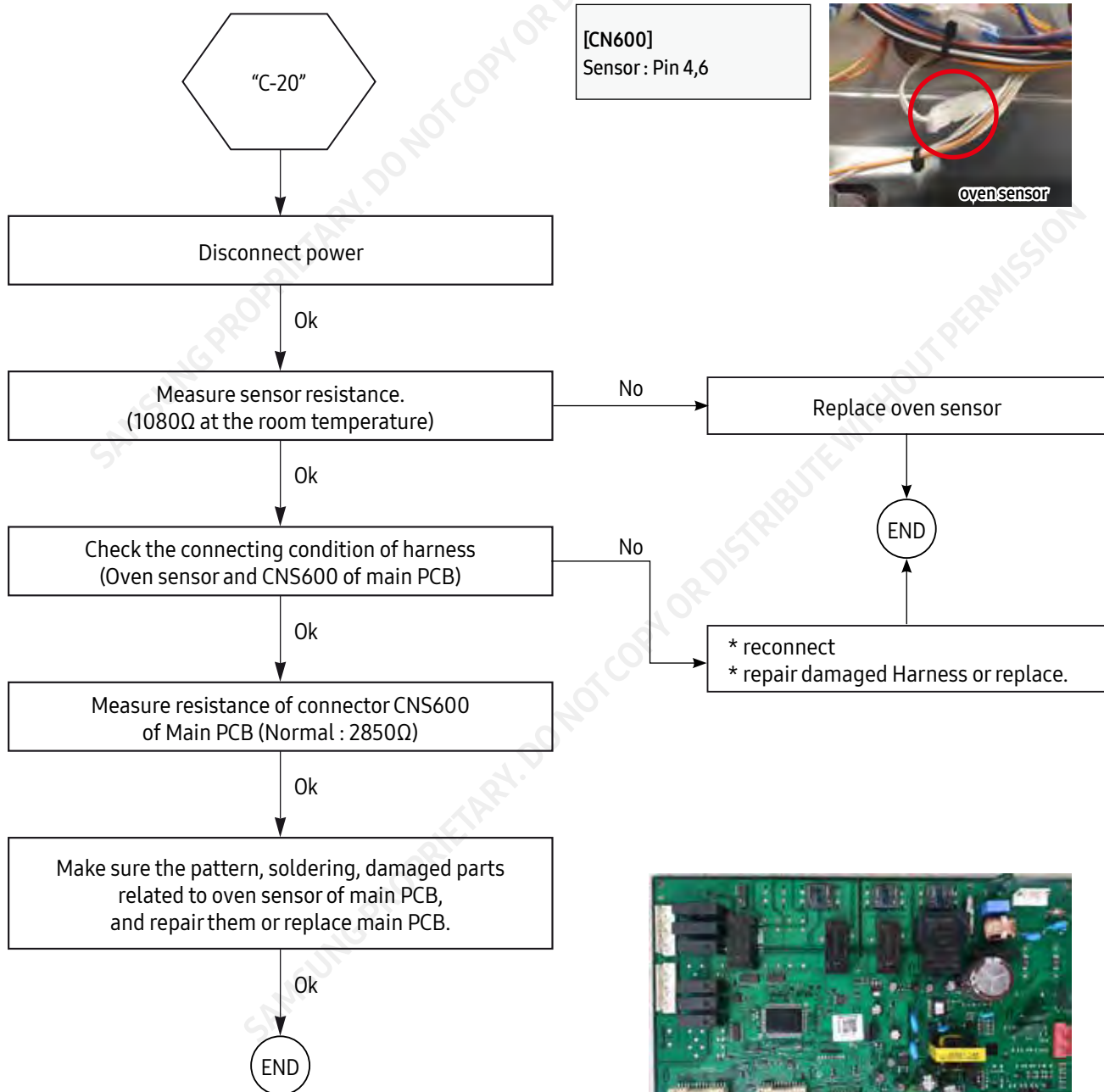

4. Troubleshooting

Failure Display Codes

Information code	Meaning	SOLUTION
C-21	Oven heating over	<ol style="list-style-type: none"> 1. Disconnect power . Open the back cover . Disconnect sensor harness from control .Measure sensor resistance :1kΩ at the room temperature → If there are any problems, replace oven sensor . 2. Check the broil, bake and convection heater . Check the resistance of the each heater . 3. Check whether DLB, Broil, Bake and Convection heater relay are working normally . 4. Check whether there is any disconnection of harness which is linked with main PCB on main PCB . 5. Check the resistance of oven sensor connector on main PCB . (Normal : 2850Ω)

4. Troubleshooting

Failure Display Codes

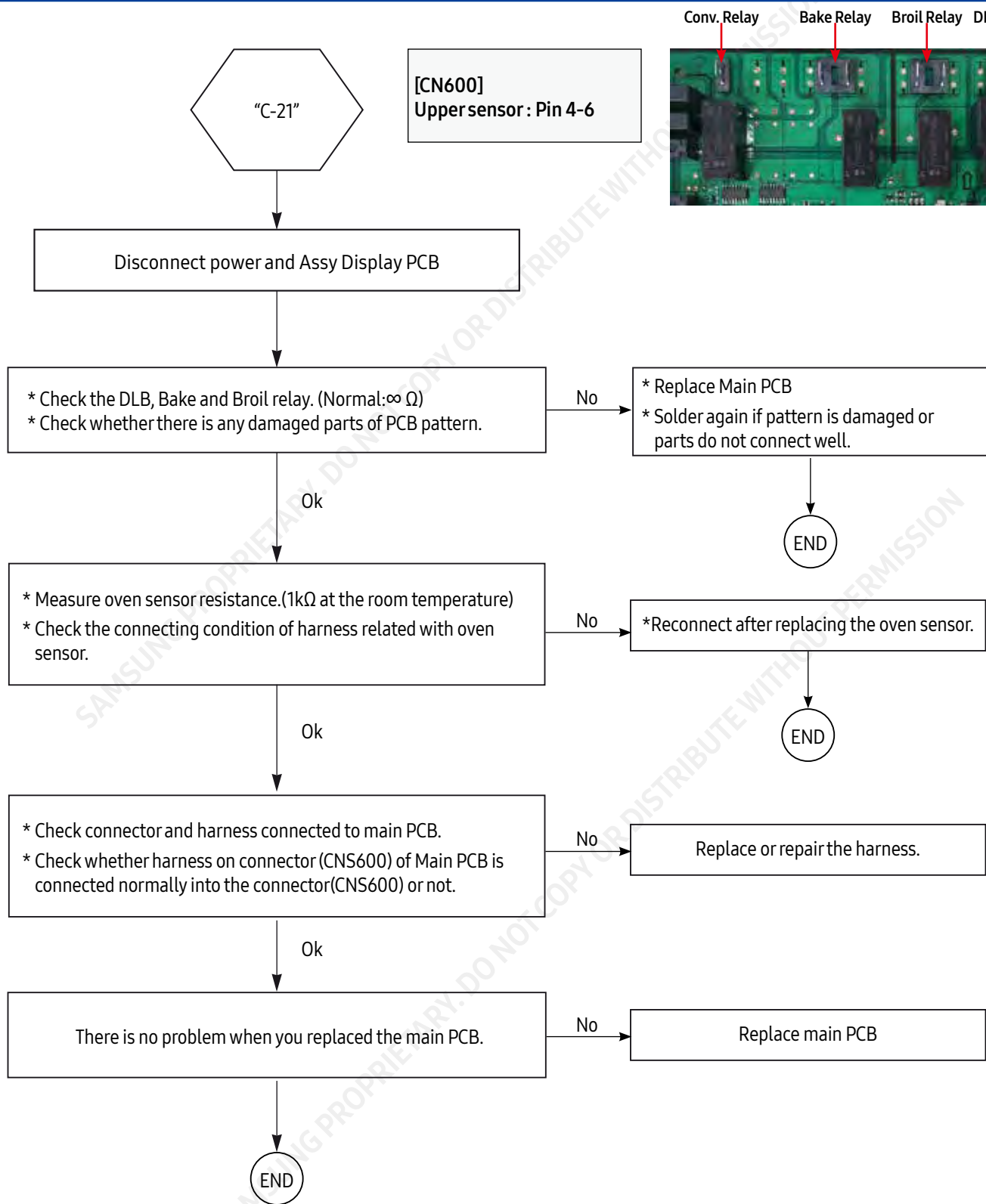

4. Troubleshooting

Failure Display Codes

Information code	Meaning	SOLUTION
C-d0	Key Short	<ol style="list-style-type: none"> 1. Clean the touch panel and make sure there is no water on/ around them. 2. If the problem continues, replace sub PCB. * If key data 30sec over keeping, IC reset. (Touch model)
C-d1	Door locking information	<ol style="list-style-type: none"> 1. Disconnect power . Open the back cover .Check whether harness has been connected with door lock switch and motor . 2. Confirm whether resistance value of door lock motor is normal. 3. With operating door lockout, measure a voltage of connector on harness which is linked with door lock motor . (Normal Voltage : AC120V) 4. Check whether door locking switch is working.

4. Troubleshooting

Failure Display Codes

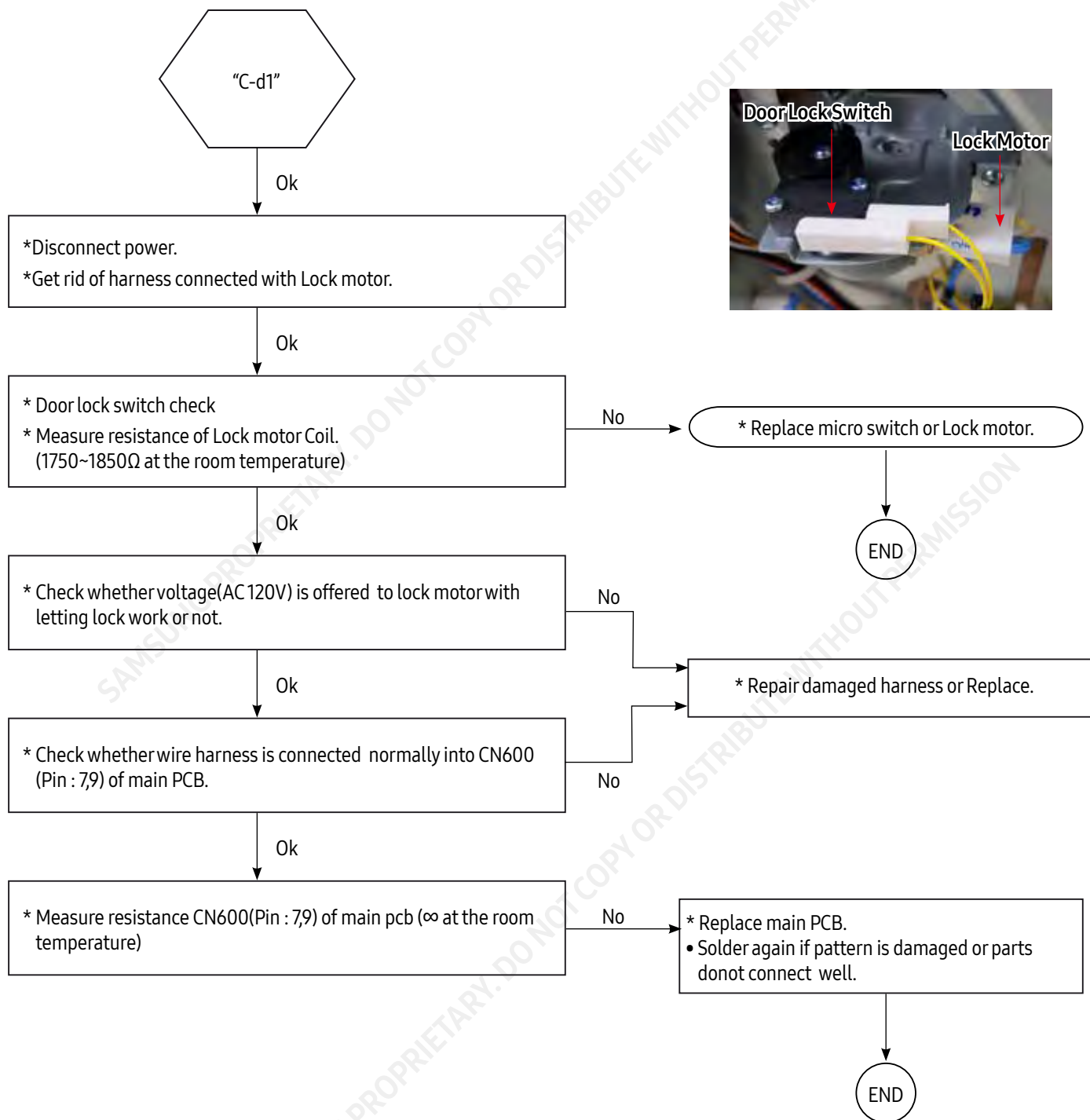

4. Troubleshooting

Failure Display Codes

Information code	Meaning	SOLUTION
C-F0	1. Main ↔ Sub module communication information 2. Sub ↔ LCD communication information	1. Check Wire Harness - Main ↔ Sub · Main : CNS600, Sub : CNS202 - Sub ↔ LCD · Sub : CNS200, LCD : CN103 2. Replace Sub PCB 3. Replace Main PCB 4. Replace Assy Display Module

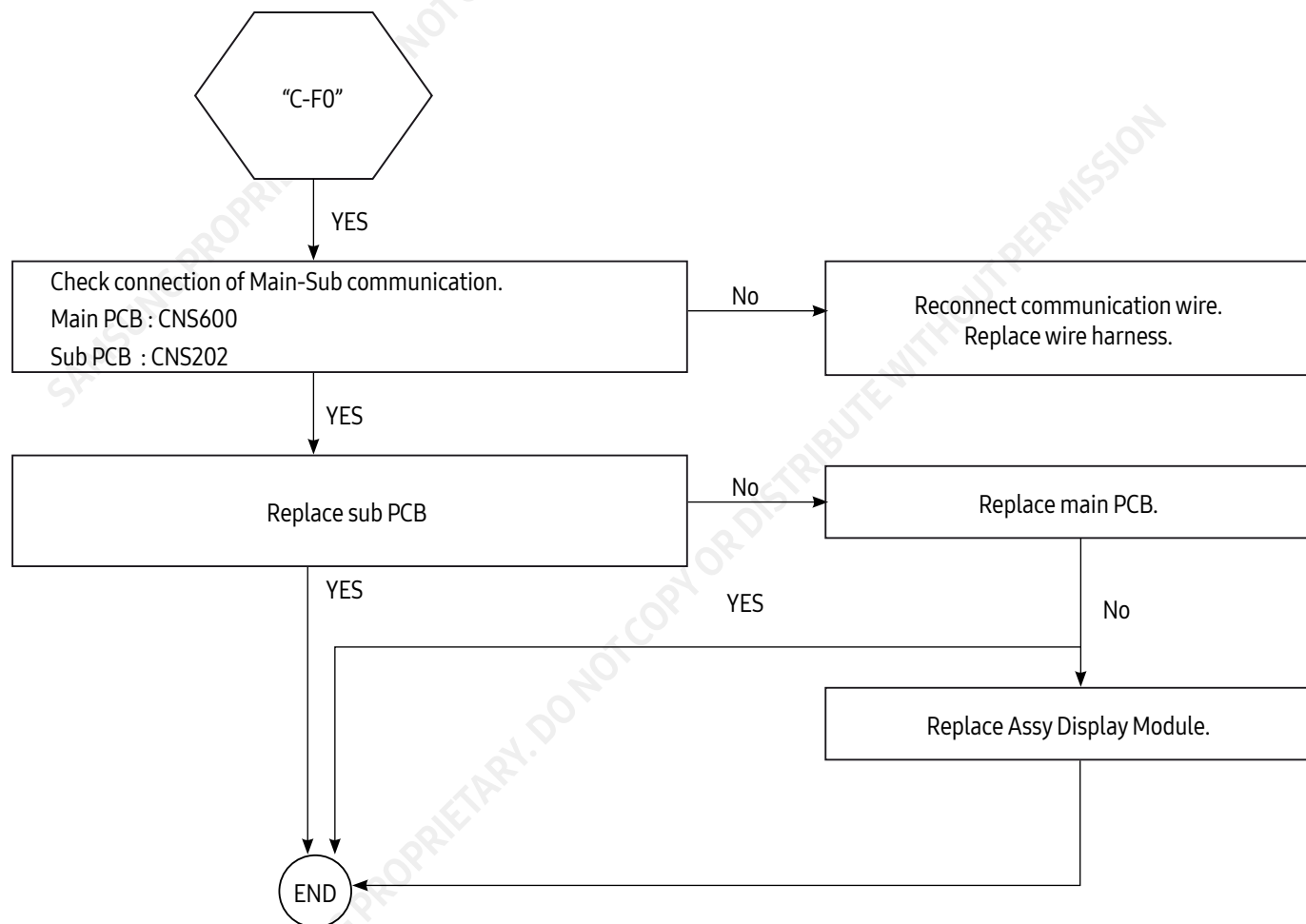

4. Troubleshooting

Failure Display Codes

Information code	Meaning	SOLUTION
C-F2	Main↔Touch communication information	<ol style="list-style-type: none"> 1. Check if touch film tail is connected fully. 2. Replace Assy display module. 3. Replace Assy Control Box.

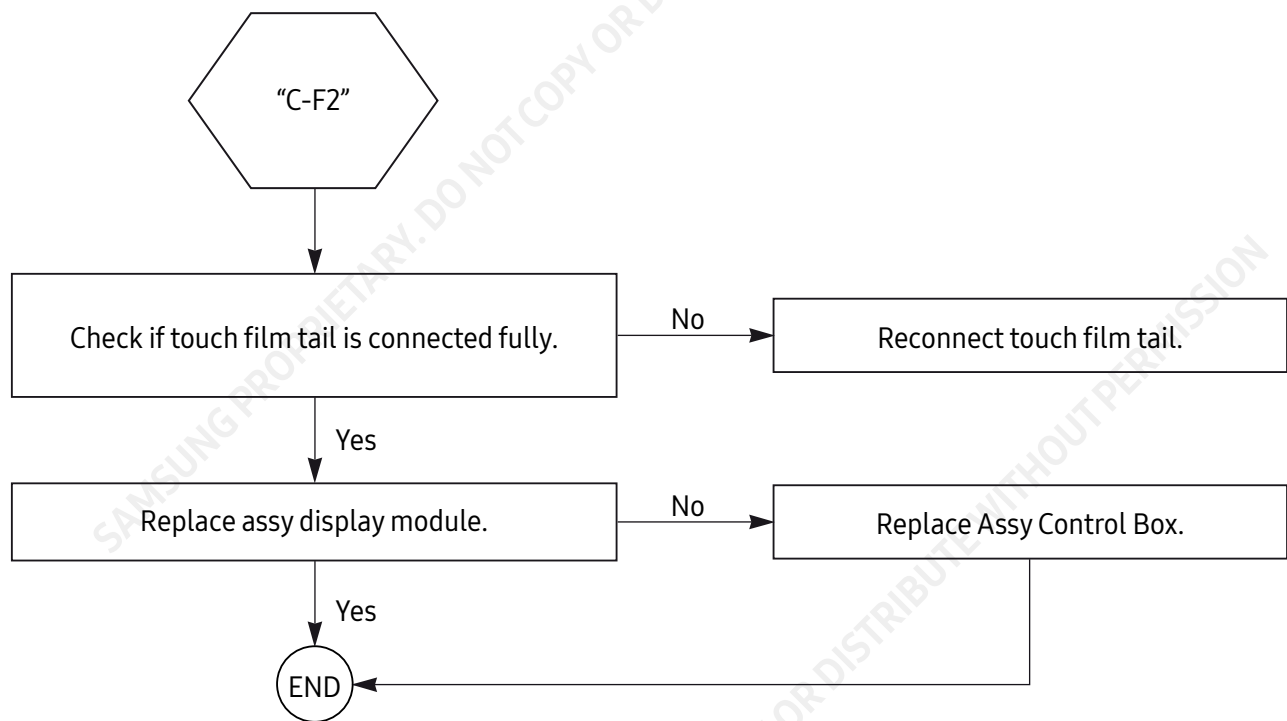

4. Troubleshooting

Failure Display Codes

Information code	Meaning	SOLUTION
C-A2	Ambient Temperature of Sub PCB very hot	1. To reset error, disconnect power or press "OFF" key 2. Operate the oven to Broil Mode to check cooling fan rotation. 3. If cooling fan is locked, replace the cooling Fan

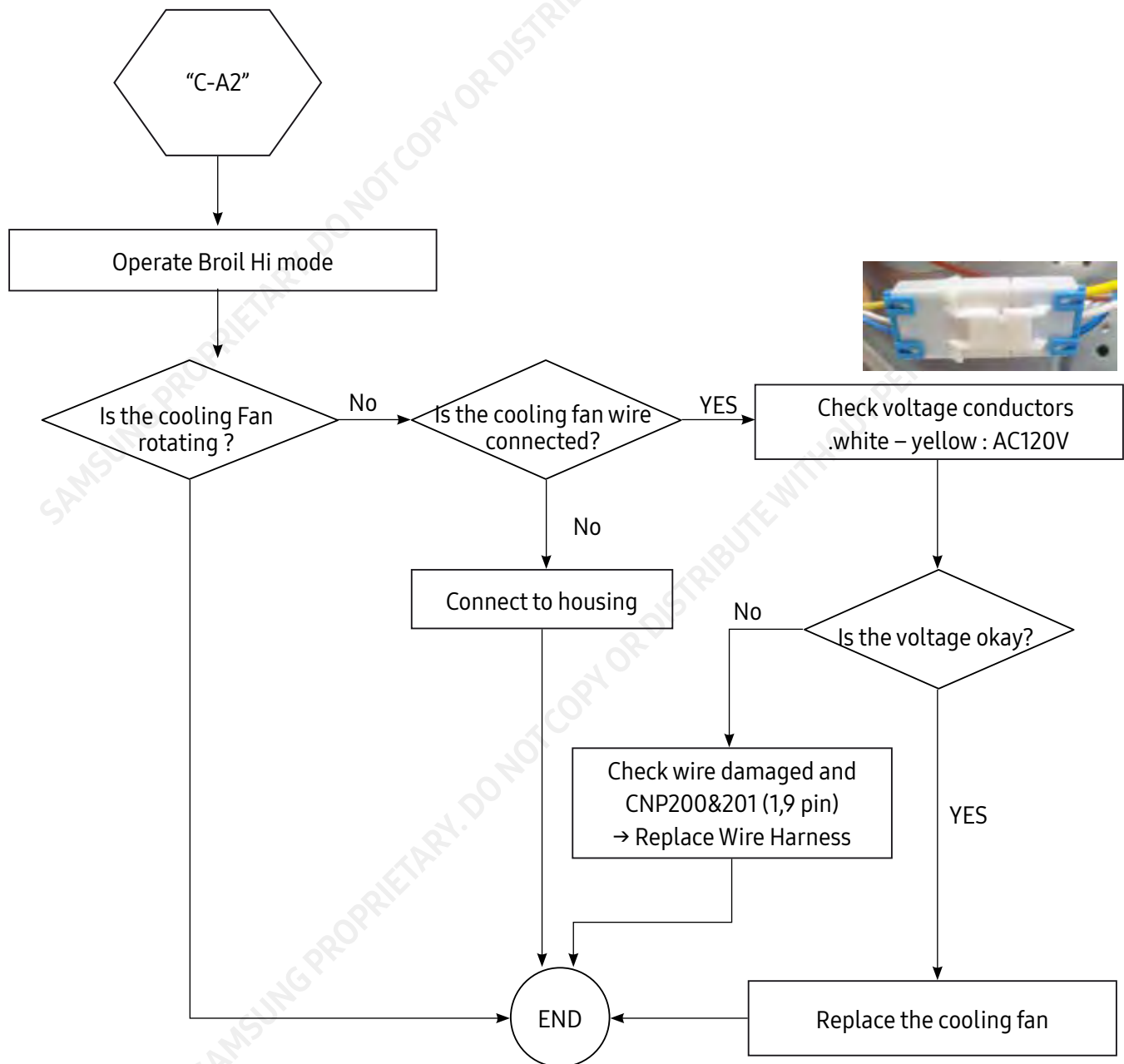

4. Troubleshooting

Failure Display Codes

Information code	Meaning	SOLUTION
C-24	Oven vent blocked	<ol style="list-style-type: none"> 1. To reset error, disconnect power or press 'Off' key after opening the oven door at least 60sec 2. Check whether oven vent or cover air is blocked by aluminum foil or others 3. Remove aluminum foil or others on oven vent or cover air blocked

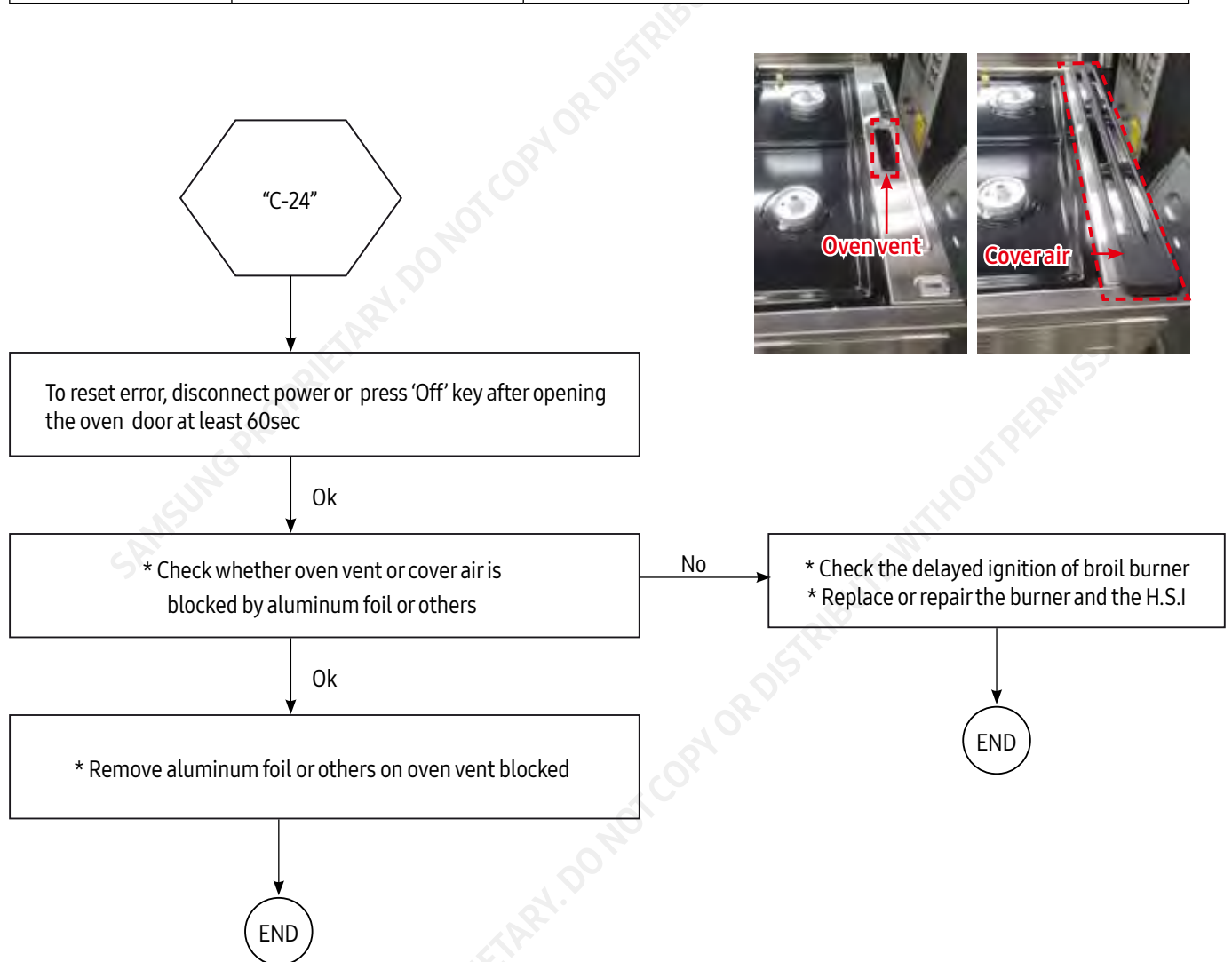

4. Troubleshooting

Error Trouble Shooting

SYMPTOM	DIAGNOSIS	REMEDY
Oven not operating (No power, No display)	* Measure the input voltage at the plug. (120VAC)	* Check the circuit breaker or fuse for the range circuit. * Make sure all wires are connected to the PCB.
	* Measure the voltage at the CNP100 connector on the PCB. (Pin - 3, 5 :120VAC) * Measure the voltage at the CNP101 connector on the PCB. (Pin - 1, 3 :120VAC)	* Repair or replace the loose or disconnected harness.
	* Measure resistance both ends of terminal on thermostat. (normal : 0 ohms) * Check whether harness is connected terminal on thermostat has been loosen or disconnected.	* Replace the thermostat. * Replace or repair harness. * Replace or repair after confirming the state of working of main PCB
Oven temperature rises too slowly	* Make sure that the bake, broil, and Double Line Break relays on the PCB are working normally. * Make sure the harness connections at the PCB terminals have not come loose or disconnected. (Bake : TB207, BROIL : TB204, DLB : TB201)	* Replace the PCB if a relay has been damaged; relay is not working properly; or if the PCB has a crack in it. * Tighten or reconnect the PCB harness connections. * After confirming the harness has been connected properly to the PCB, take the following action: - Repair or replace the harness. - Replace the PCB.
	* Measure the resistance between both ends of the oven temperature sensor. (normal : 1K ohms) * Make sure the harness connections at the PCB connector CNS600 have not come loose or disconnected. (Upper sensor : Pin 4,6)	* Replace the oven temperature sensor. * Repair or replace the harness. * If problem still exists after confirming the oven temperature sensor and harness are working and connected properly, replace the PCB.

4. Troubleshooting

Error Trouble Shooting

SYMPTOM	DIAGNOSIS	REMEDY												
Oven temperature rises too slowly.	* Make sure the harness connections at the PCB terminals have not come loose or disconnected. (Bake : TB207, BROIL : TB204, DLB : TB201)	* Repair or replace the harness.												
	* Make sure the broil and bake burners have been adjusted properly. * Make sure the oven burner orifices are sized properly for the type of gas being used.	* Open or close the air shutter at the base of the burners to optimize the flame pattern. * Replace with properly sized orifices: <table border="1" style="margin-left: 20px;"> <thead> <tr> <th>Burner</th> <th>NG</th> <th>LP</th> </tr> <tr> <th>Orifice</th> <th>mm</th> <th>mm</th> </tr> </thead> <tbody> <tr> <td>Broil</td> <td>1.8</td> <td>1.12</td> </tr> <tr> <td>Bake</td> <td>1.90</td> <td>1.15</td> </tr> </tbody> </table> <p>NOTE: High-altitude orifice kits are available.</p>	Burner	NG	LP	Orifice	mm	mm	Broil	1.8	1.12	Bake	1.90	1.15
	Burner	NG	LP											
Orifice	mm	mm												
Broil	1.8	1.12												
Bake	1.90	1.15												
* Make sure that the bake, broil, and source control relays on the PCB are working normally.	* Repair or replace the faulty relay. * Make sure all harness connections are properly connected. * Replace the PCB.													
Oven temperature rises too fast.	* The oven temperature exceeds 400°F(204°C) within 10 minutes of room temperature operation.	* Repair or replace the faulty broil or bake relay.												
	* Make sure the harness is wired correctly and does not have a short circuit in it.	* Repair or replace the harness.												
	* Make sure the oven burner orifices are sized properly for the type of gas being used.	* Replace with properly sized orifices: <table border="1" style="margin-left: 20px;"> <thead> <tr> <th>Burner</th> <th>NG</th> <th>LP</th> </tr> <tr> <th>Orifice</th> <th>mm</th> <th>mm</th> </tr> </thead> <tbody> <tr> <td>Broil</td> <td>1.8</td> <td>1.12</td> </tr> <tr> <td>Bake</td> <td>1.90</td> <td>1.15</td> </tr> </tbody> </table> <p>NOTE: High-altitude orifice kits are available</p>	Burner	NG	LP	Orifice	mm	mm	Broil	1.8	1.12	Bake	1.90	1.15
Burner	NG	LP												
Orifice	mm	mm												
Broil	1.8	1.12												
Bake	1.90	1.15												

4. Troubleshooting

Error Trouble Shooting

SYMPTOM	DIAGNOSIS	REMEDY
Touch control keypads are not working properly.	* Make sure the door lock feature is not turned on.	* Unlock the controls by pressing and holding the lock key for 3 or more seconds.
	* Check to see if the Sabbath function has been turned on..	* Press and hold the (Bake turning on) Setting+Lamp for at least 3 seconds. * The display will show the time of day when the function is turned off
	* Check the display control harness and connectors (CNS200) on the PCB Touch control film tail on the PCB	* Reconnect securely or replace damaged membrane control harness.
	* Check connectors (CNS200, touch film) and/or the PCB for damage. * Check the membrane control panel for damage.	* Replace the PCB assembly. (PCB and control touch panel.)
Oven lamp is not working.	* Make sure the door lock feature is not turned on.	* Unlock the controls by pressing and holding the lock key for 3 or more seconds.
	* Check for a burned out bulb.	* Replace with a 40 watt appliance bulb.
	* Check the harness connections (CNP200&201 Pin :3), and the oven lamp relay (RY214)	* Repair or replace loose or disconnected harness. * Replace any malfunctioning relays.
	* Measure the resistance across the light ballast/socket terminals. (Normal : ∞)	* Replace the light ballast/socket. * Replace the PCB.
Convection fan is not rotated.	* Check the harness and harness connector (CNP200&201 Pin : 11,13) on the PCB and at the terminals at each convection motor).	* Reconnect a loose or disconnected harness or replace a damaged harness.
	* Check the display control harness and connectors (CNS200) on the PCB Touch control film tail on the PCB.	* Reconnect securely or replace a damaged membrane control harness.
	* Check the convection fan relay (SSR200,201/R Y211,212) and the connector (CNP200&201) on the PCB.	* Replace the malfunctioning relay. * Replace the PCB
	* Measure the resistance across the fan motor terminals	* Replace the burned out fan motor.

4. Troubleshooting

Error Trouble Shooting

SYMPTOM	DIAGNOSIS	REMEDY
The oven smells and/or smokes when it is initially started.	* This is normal.	<ul style="list-style-type: none"> * The insulation around the oven will give off a slight odor until the adhesive has cured. This should go away after the first couple of oven uses. * The oven is designed to burn off dirt and/or foreign substances. * If the oven is dirty, run a self-cleaning cycle. (See page 36 in the "User Manual".) A ventilation system should be used while the oven is self cleaning.
The LCD display is dim or not visible.	* Check the display control harness and connectors (CNS200) on the PCB Touch control film tail.	<ul style="list-style-type: none"> * Reconnect securely or replace a damaged membrane control harness. * Replace the PCB assembly. (PCB and control touch panel.)
The buzzer does not beep when a keypad is touched.	<ul style="list-style-type: none"> * Check to see if the Sabbath function has been turned on. * The buzzer does not work on the PCB. 	<ul style="list-style-type: none"> * Press and hold the (Bake turning on) Setting+Lamp for at least 3 seconds. * The display will show the time of day when the function is turned off. * Replace the PCB
None of the cooktop burners will light.	* There is no electrical power to the range.	* Plug in the power cord and/or reset the circuit breaker for the range.
	* The gas supply valve to the range is closed.	* Open the gas supply valve.
	* Check the terminals on the spark module for voltage.	* Replace the faulty spark module(Re-Ignition).
	* Check for crimped or broken gas line between the pressure gas regulator and the surface burner control manifold.	* Replace the damaged gas line.
	* Gas pressure regulator switch is closed.	* Replace the gas pressure regulator.

4. Troubleshooting

Error Trouble Shooting

SYMPTOM	DIAGNOSIS	REMEDY
One cooktop burner does not light	* Check the harness connections at the spark module.	* Reconnect loose connection or replace damaged harness.
	* Check the spark module	* Disconnect the spark module terminal for the nonworking burner. If no voltage is measured, replace the spark module.
	* Check the electrode for that burner.	* Disconnect the electrode and check whether electrode wire or tip is broken. Replace the faulty electrode.
	* Check for a dirty surface burner orifice.	* Clean and/or replace the surface burner orifice. NOTE: Replacement orifice should always be the same size as removed.
	* Check for crimped or broken gas lines.	* Replace damaged gas lines.
	* Faulty surface burner control.	* Each surface burner control is an integral part of the surface burner control manifold. Replace the manifold.
All surface burners will light, but don't stay lit.	* Check for crimped gas line between the pressure gas regulator and the surface burner control manifold.	* Replace the damaged gas line.
	* Faulty gas pressure regulator.	* Replace the gas pressure regulator.
One cooktop burner lights, but doesn't stay lit.	* Check for a dirty surface burner orifice.	* Clean and/or replace the surface burner orifice. NOTE: Replacement orifice should always be the same size as removed.
	* Check for a crimped gas line.	* Replace the crimped gas line.
	* Faulty surface burner control.	* Each surface burner control is an integral part of the surface burner control manifold. Replace the manifold.
Cooktop burner flames are soft blue or have yellow tips.	* This is normal.	* Soft blue flames are normal flames for NG operation. * Soft blue flames with yellow tips are normal flames for LP operation.

4. Troubleshooting

Error Trouble Shooting

SYMPTOM	DIAGNOSIS	REMEDY	
Cooktop burner flames are mostly yellow.	* Check for proper sized orifices:	* Replace any wrong sized orifices.	
	LF		NG LP
	LR		0.68 /1.60 0.50 /1.04
	RF	0.68 /1.60 0.50 /1.04	
	RR	0.85 /1.29 * 2 0.43 / 0.83 * 2	
	RR	0.61 /1.20 0.50 / 0.78	
	NOTE: High-altitude orifice kits are available		
	* Check for crimped or cracked gas line between the pressure gas regulator and the surface burner control manifold	* Replace the damaged gas line.	
	* Faulty gas pressure regulator.	* Replace the gas pressure regulator.	

SAMSUNG PROPRIETARY. DO NOT COPY OR DISTRIBUTE WITHOUT PERMISSION

SAMSUNG PROPRIETARY. DO NOT COPY OR DISTRIBUTE WITHOUT PERMISSION

4. Troubleshooting

4-2 Control parts

No display

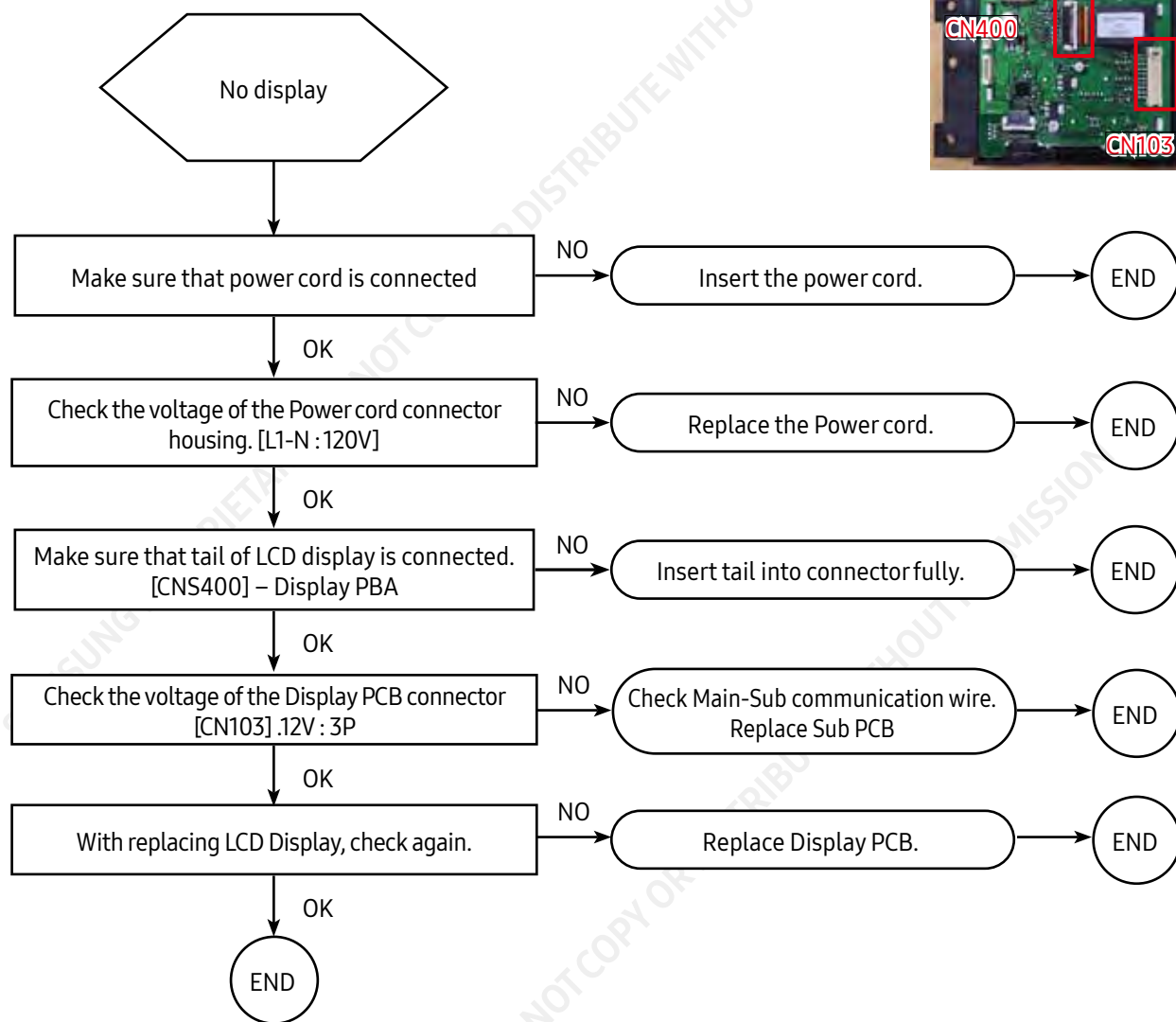

4. Troubleshooting

Control parts

Touch Keypad is not working properly

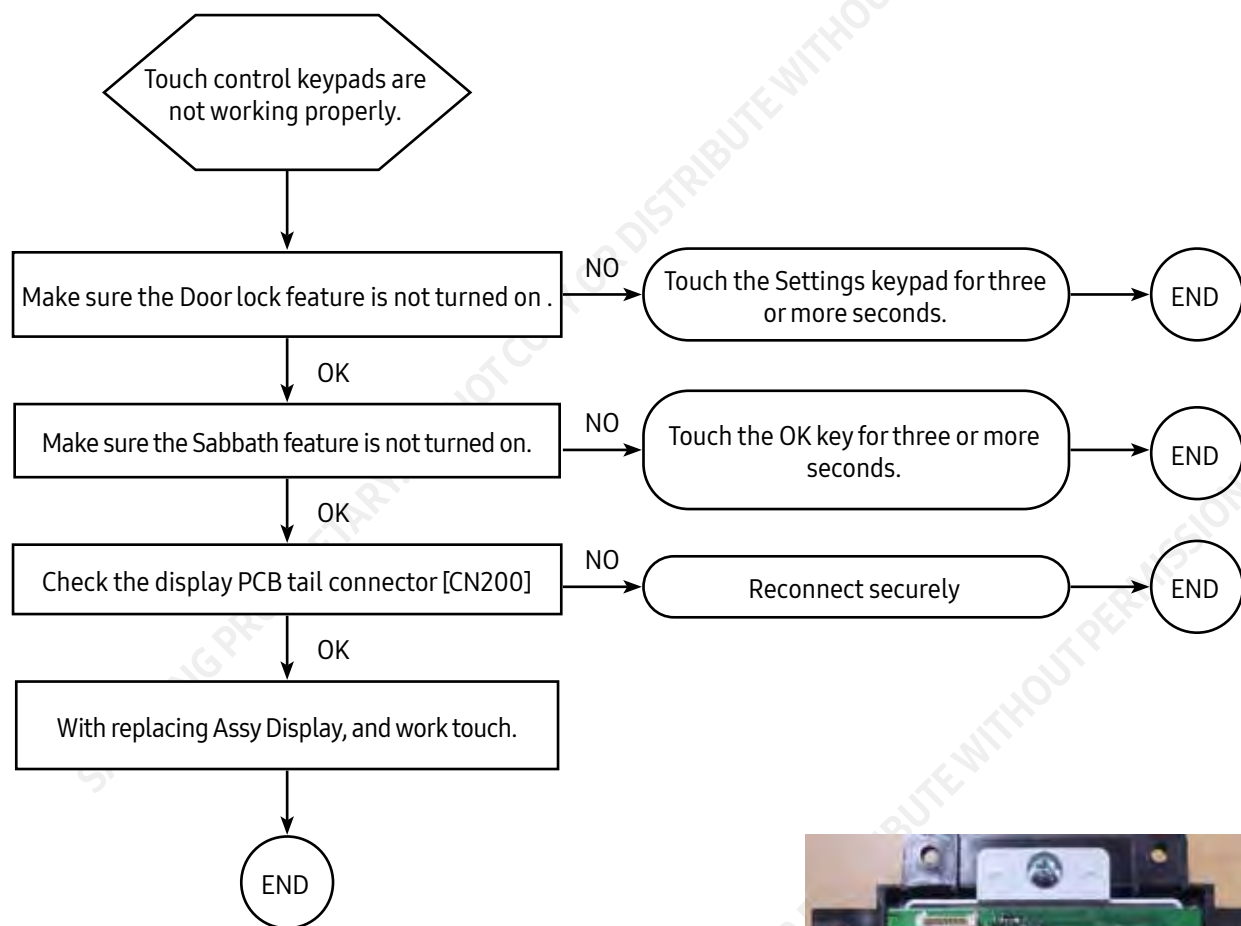

4. Troubleshooting

Control parts

Buzzer does not beep when keypad is touched

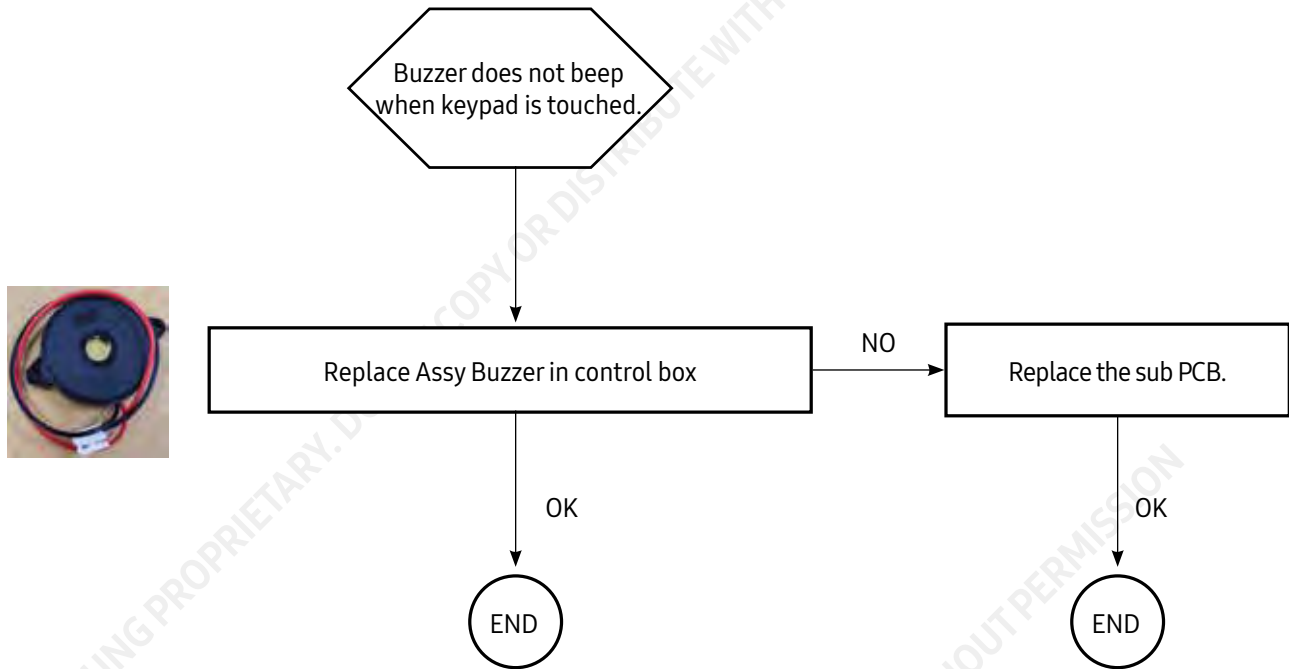

4. Troubleshooting

4-3 Cooktop parts

Cooktop burner not lighted [Gas malfunction]

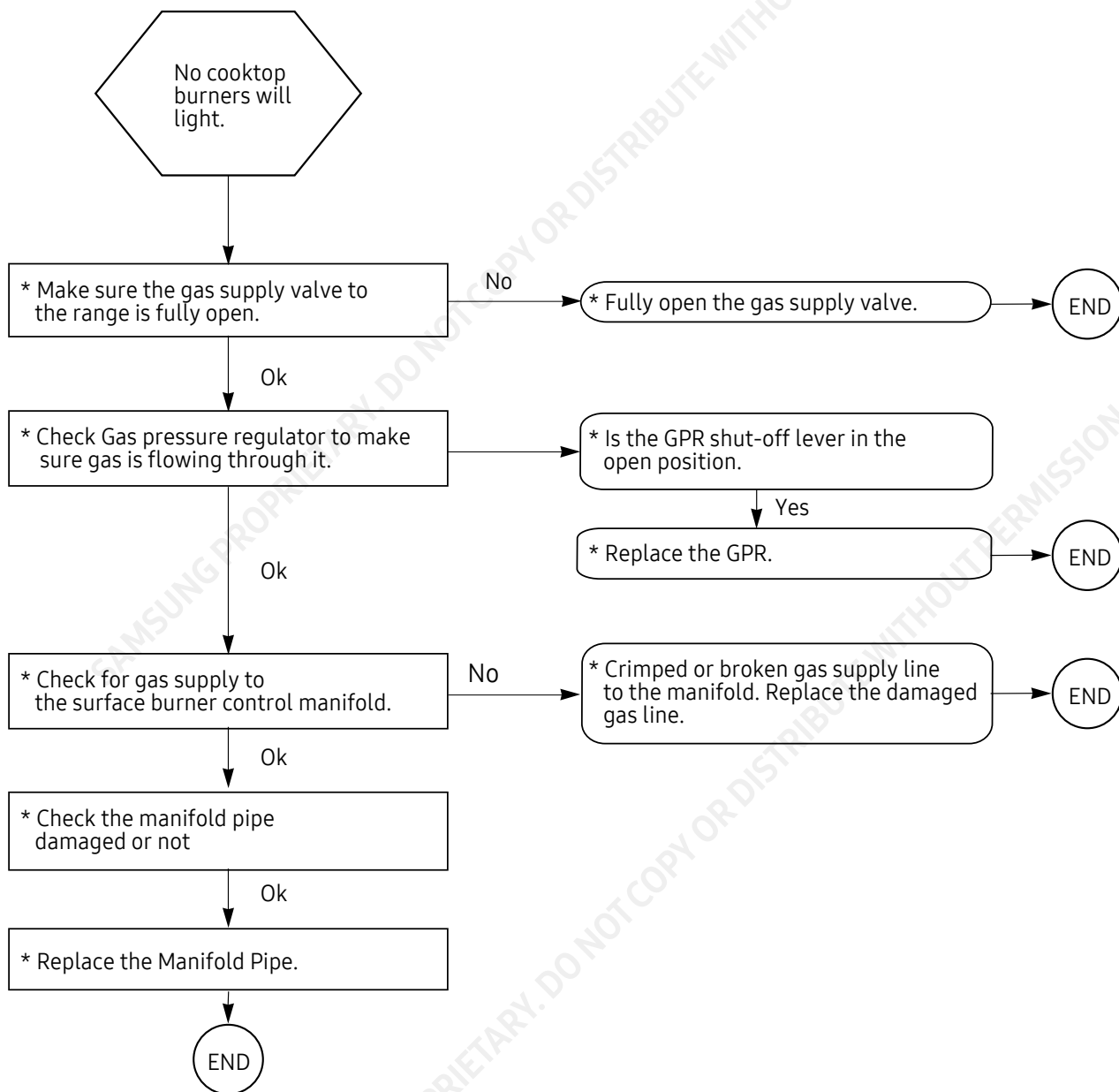

4. Troubleshooting

Cooktop parts

Cooktop burners not lighted [Electric malfunction]

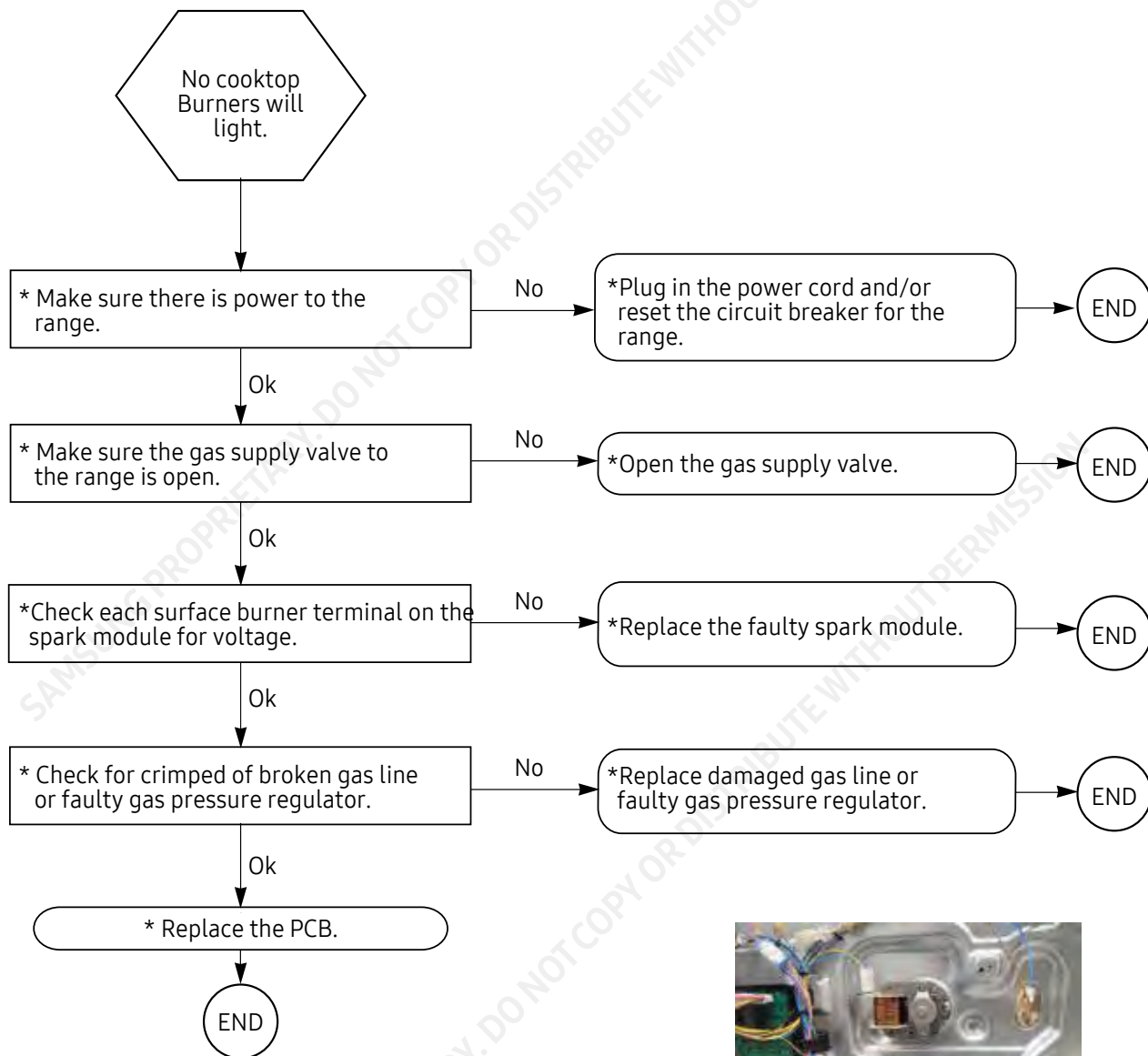

< Spark Module(Re-Ignition) >

4. Troubleshooting

Cooktop parts

One cooktop burner not lighted [Electric malfunction]

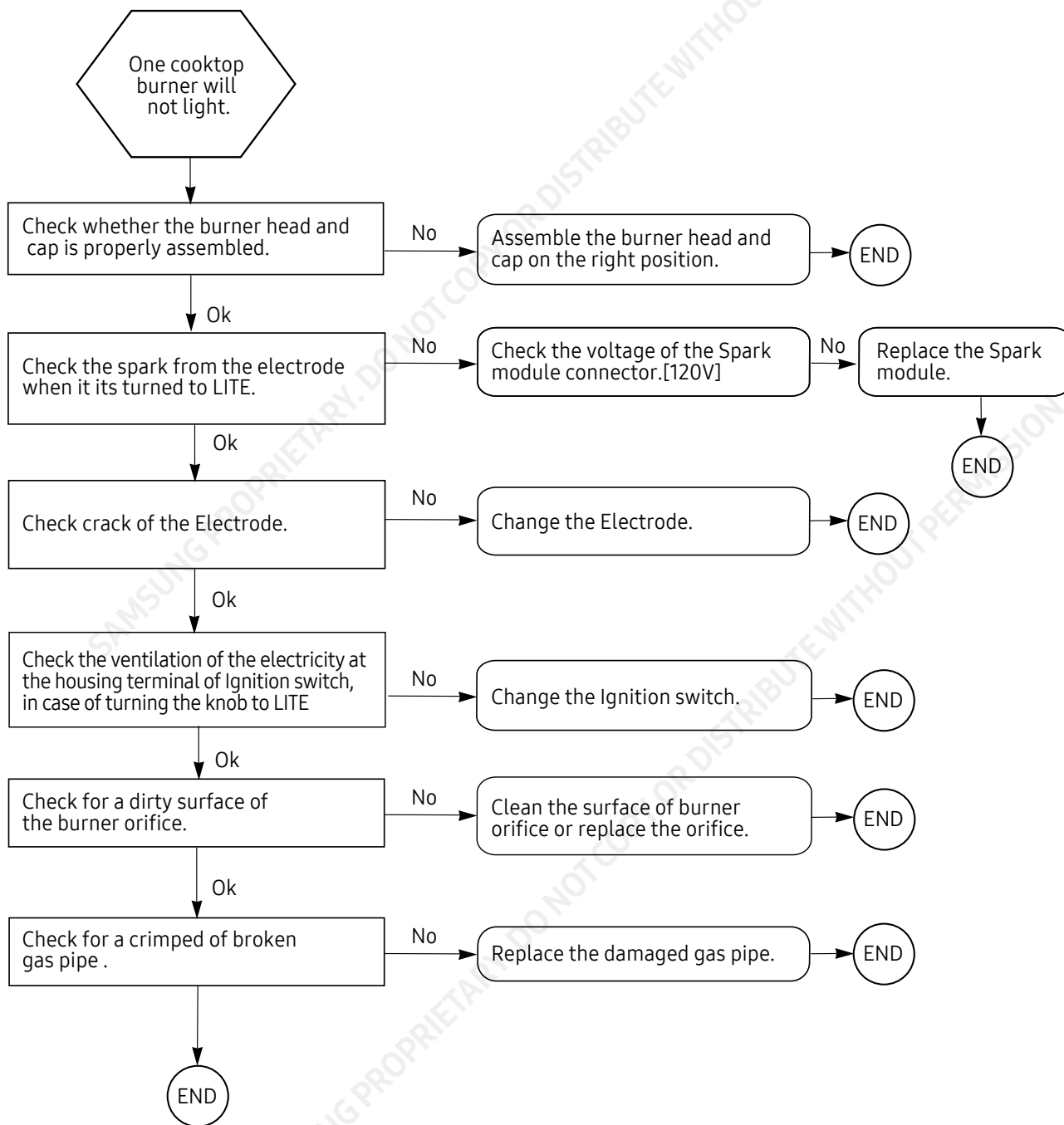

4. Troubleshooting

Cooktop / Oven parts

Gas Leaked

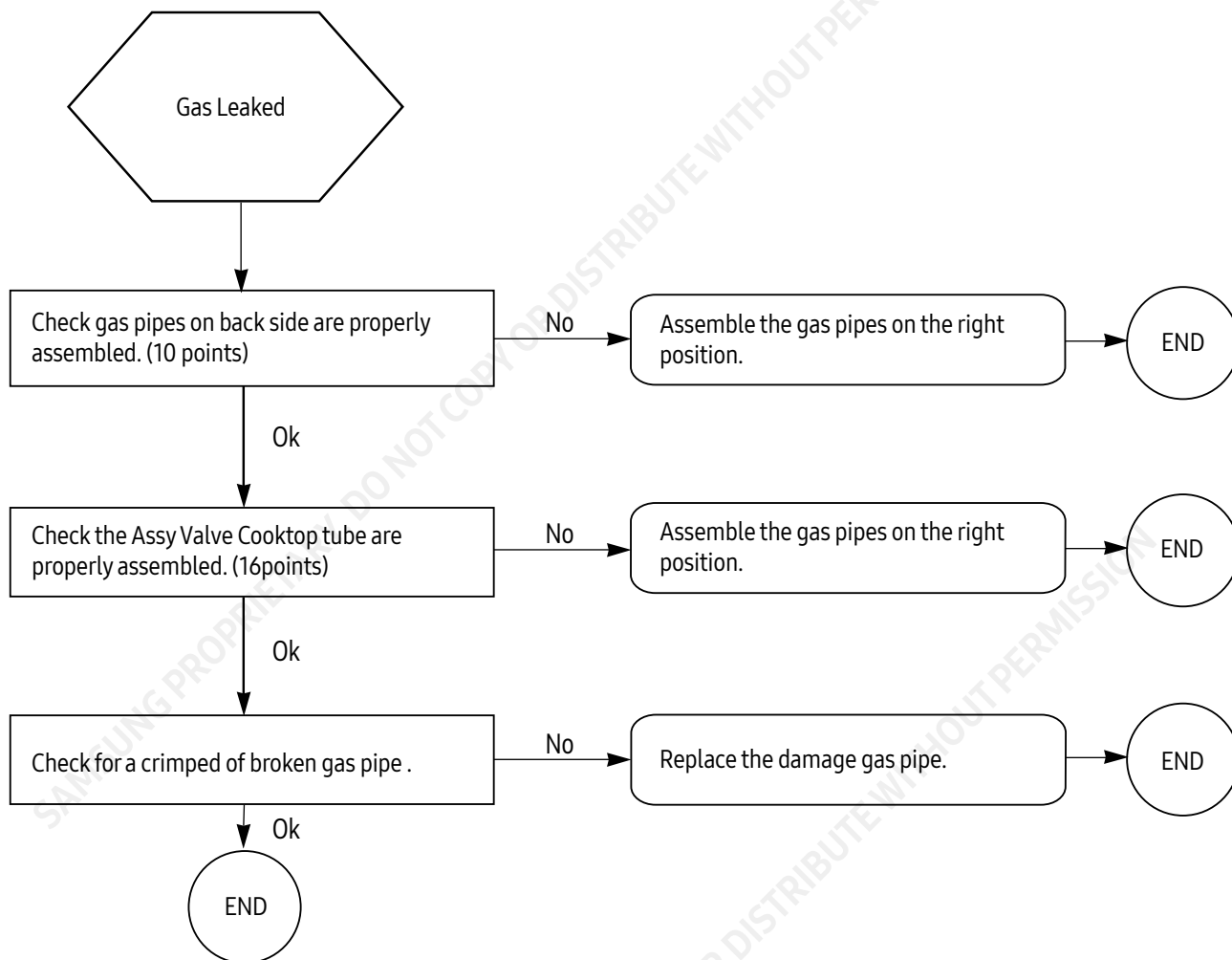

< Back Side (10 Points) >

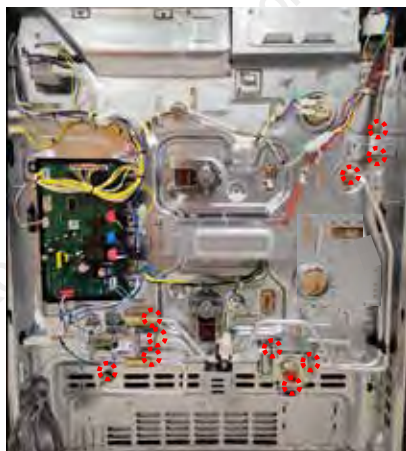

Assy Valve Cooktop (19 Points)

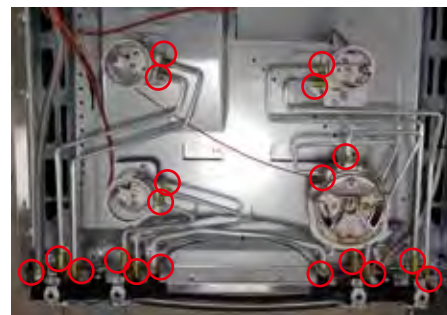

4. Troubleshooting

Cooktop / Oven parts

The flame looks abnormal. [Yellow tip / Lift flame]

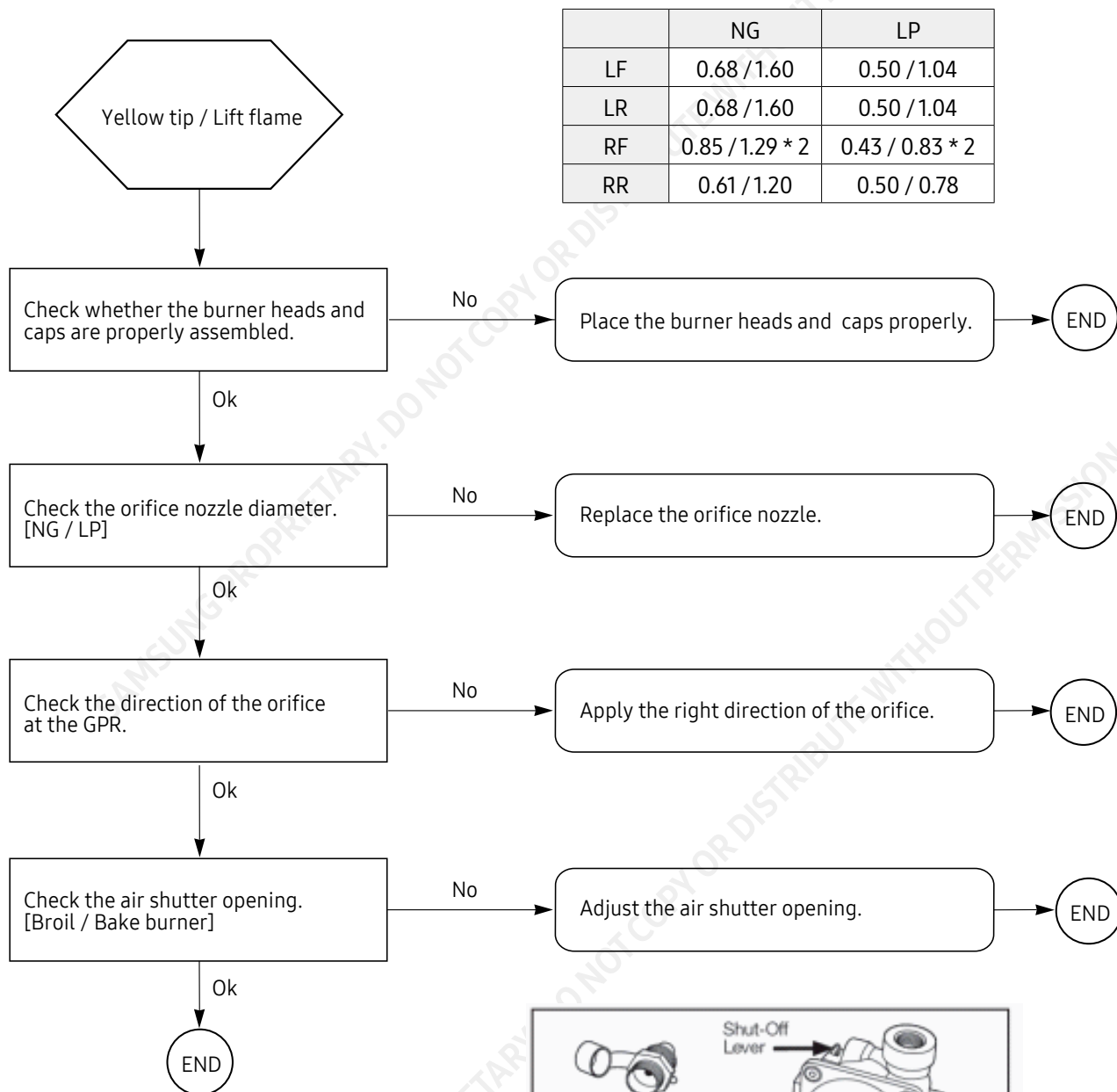

	NG	LP
LF	0.68 / 1.60	0.50 / 1.04
LR	0.68 / 1.60	0.50 / 1.04
RF	0.85 / 1.29 * 2	0.43 / 0.83 * 2
RR	0.61 / 1.20	0.50 / 0.78

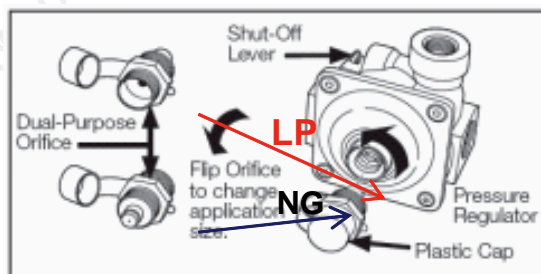

4. Troubleshooting

Cooktop / Oven parts

Flame size is too big or too small

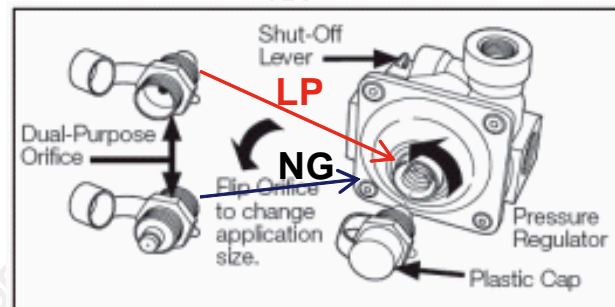
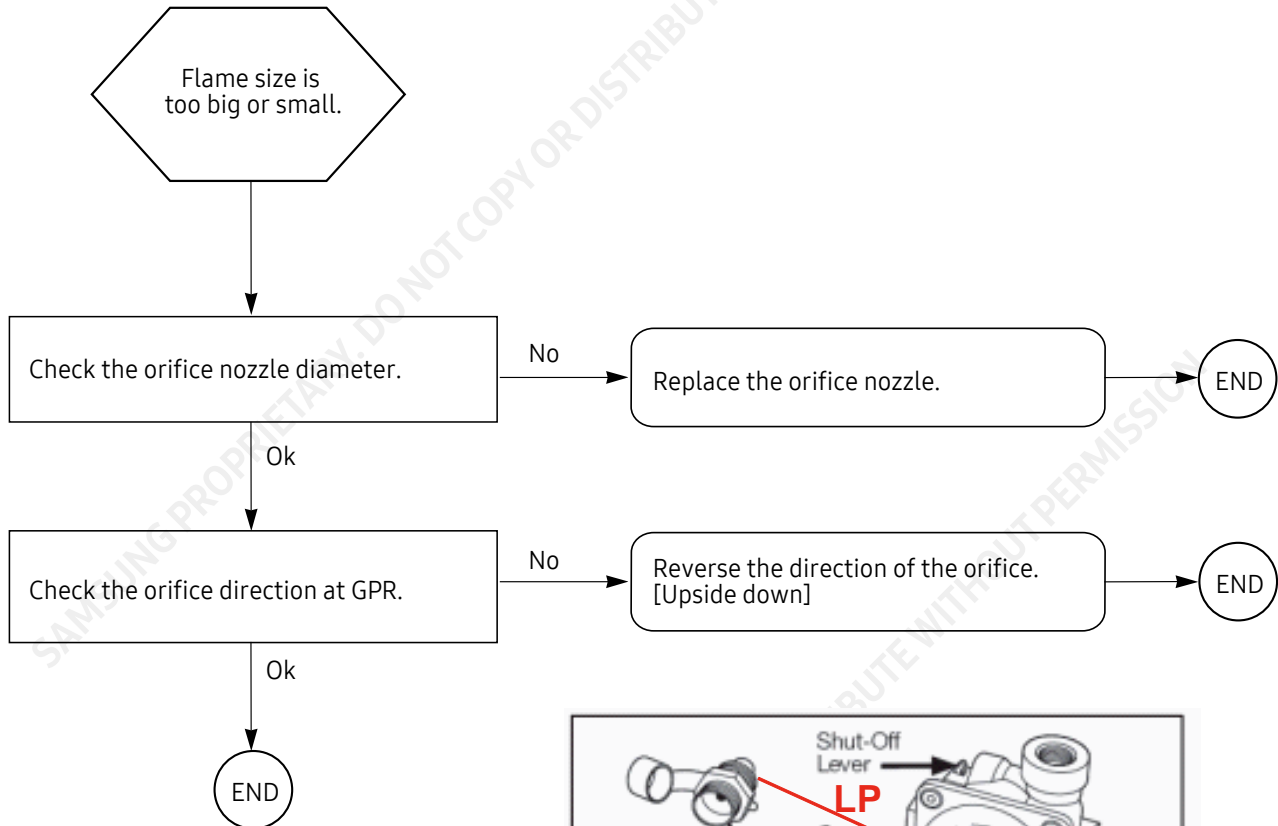

4. Troubleshooting

4-4 Oven parts

Oven burner will not light [Broil / Bake burner]

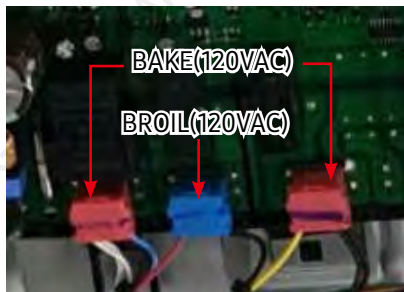
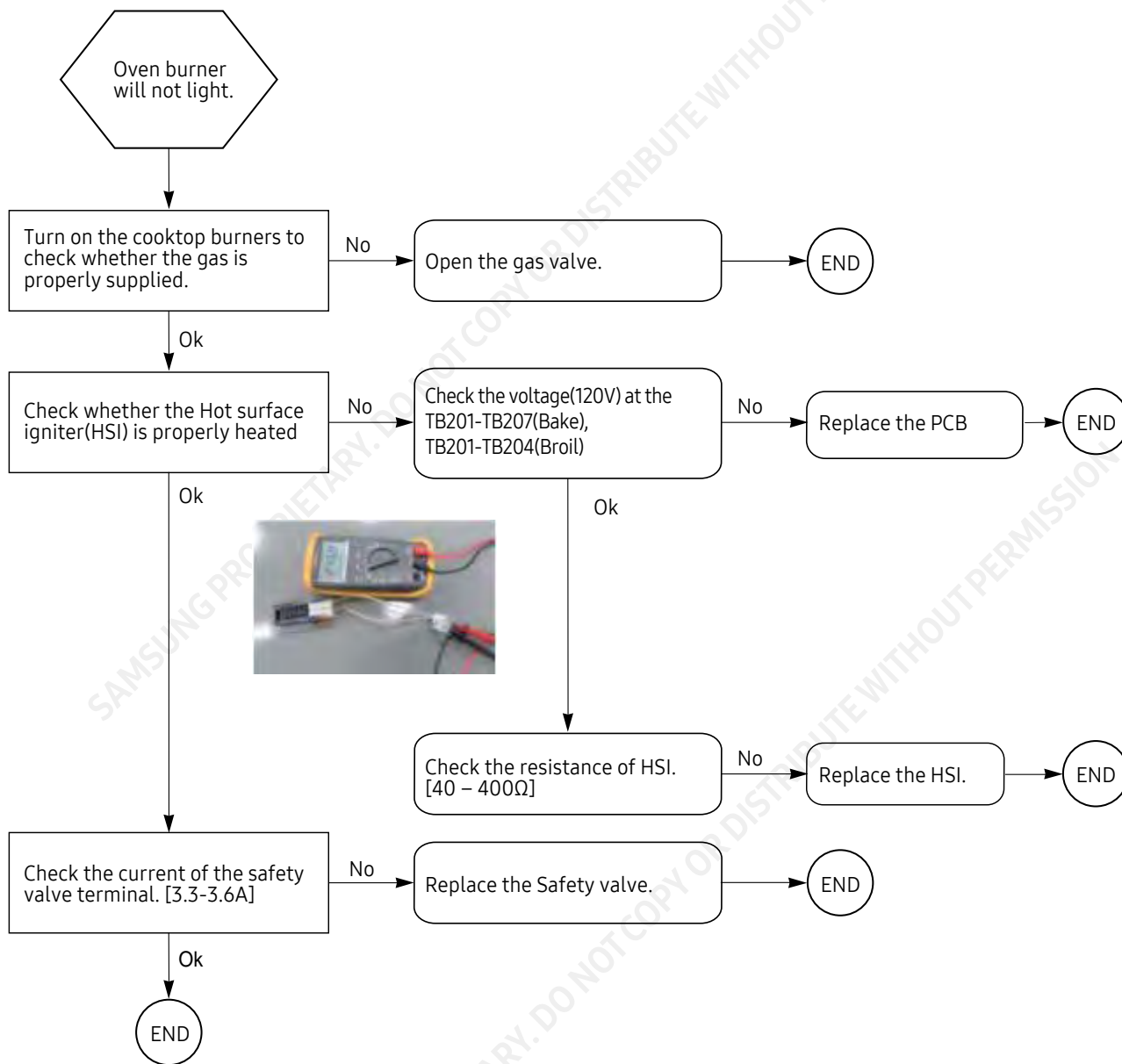

4. Troubleshooting

Oven parts

Oven temperature rises too slowly [Electric malfunction]

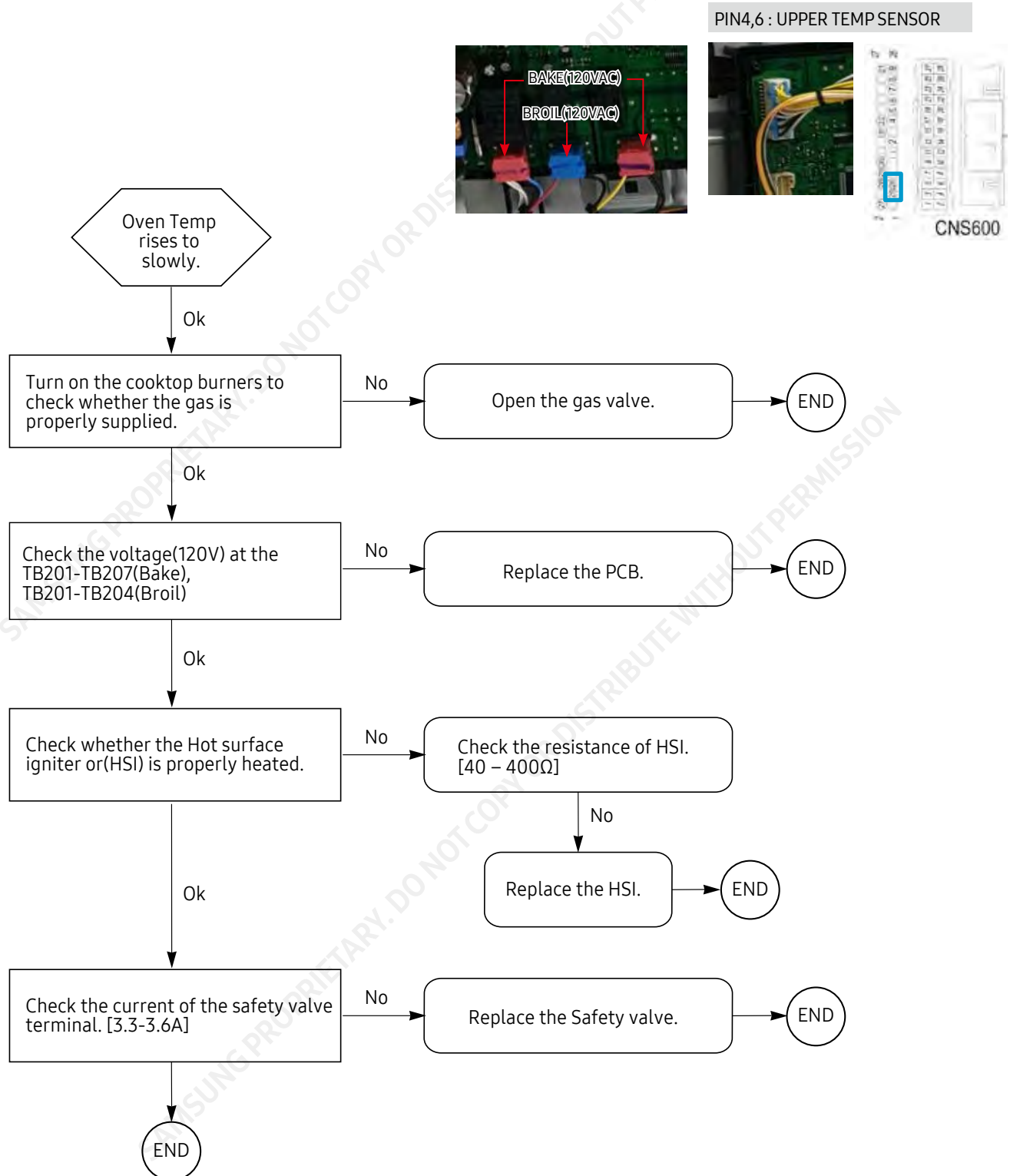

4. Troubleshooting

Oven parts

Oven temperature rises too fast. [Electric malfunction]

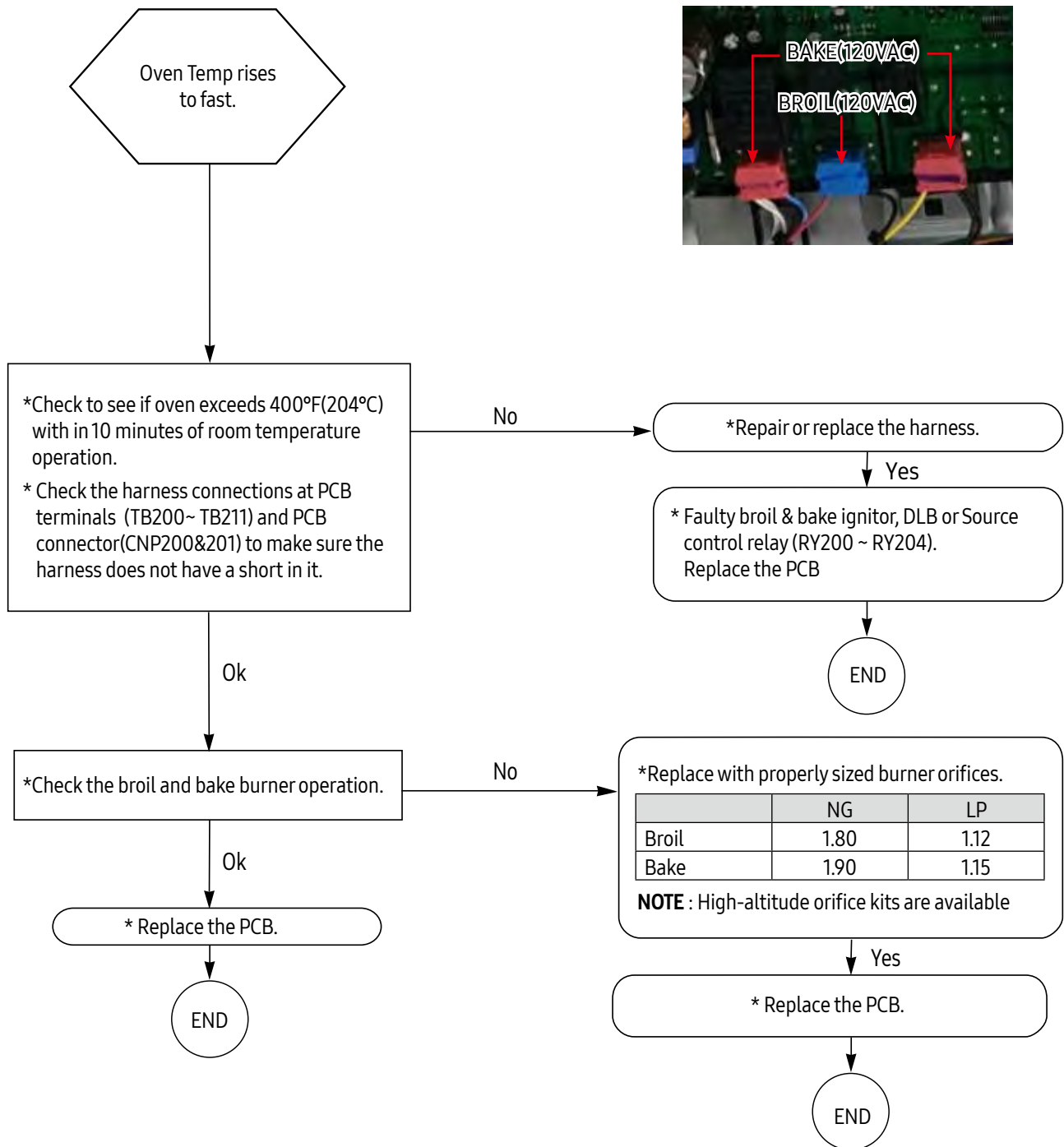

4. Troubleshooting

Oven parts

Oven temperature rises too slow or too fast [Gas malfunction]

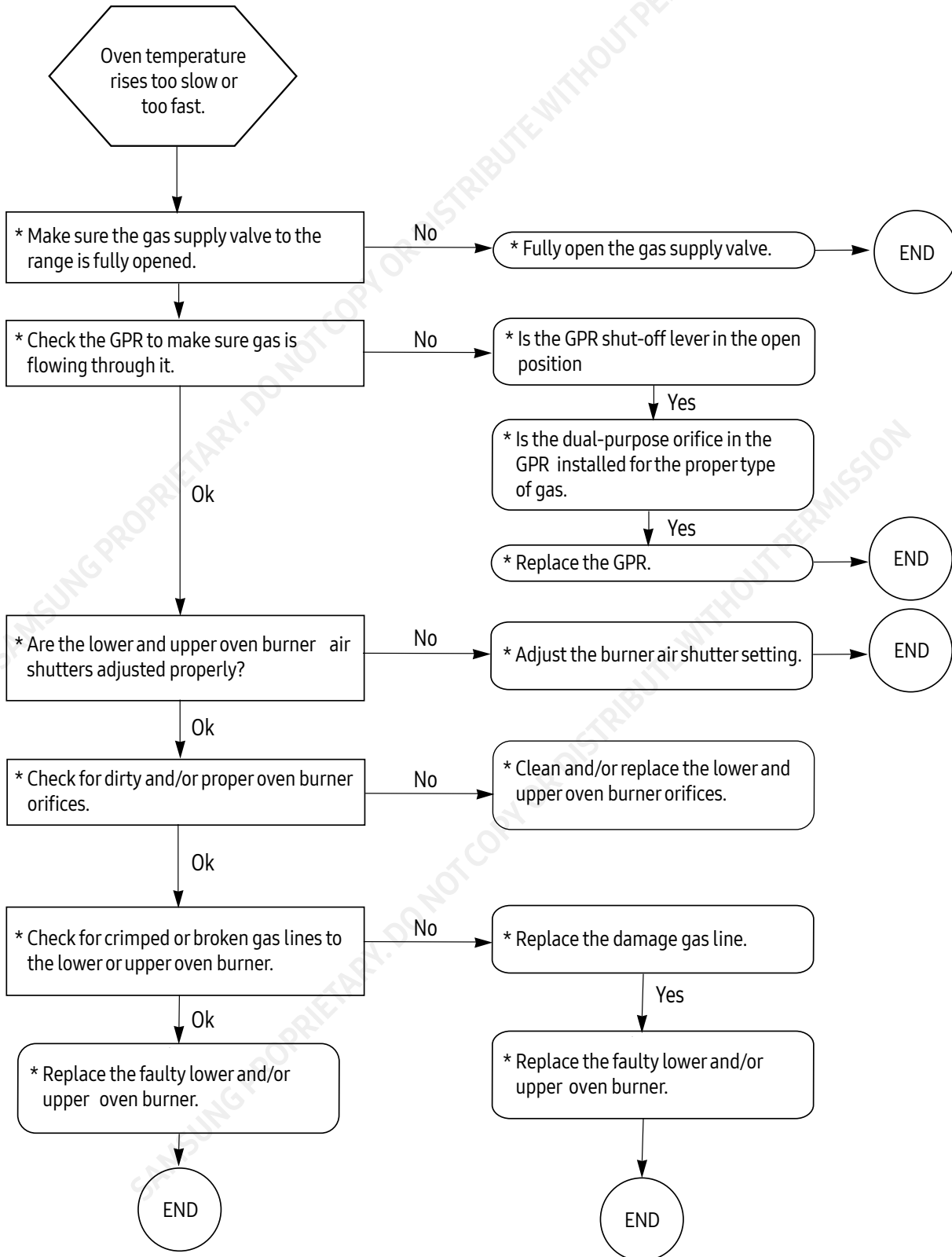

4. Troubleshooting

Oven parts

Oven lamp not working

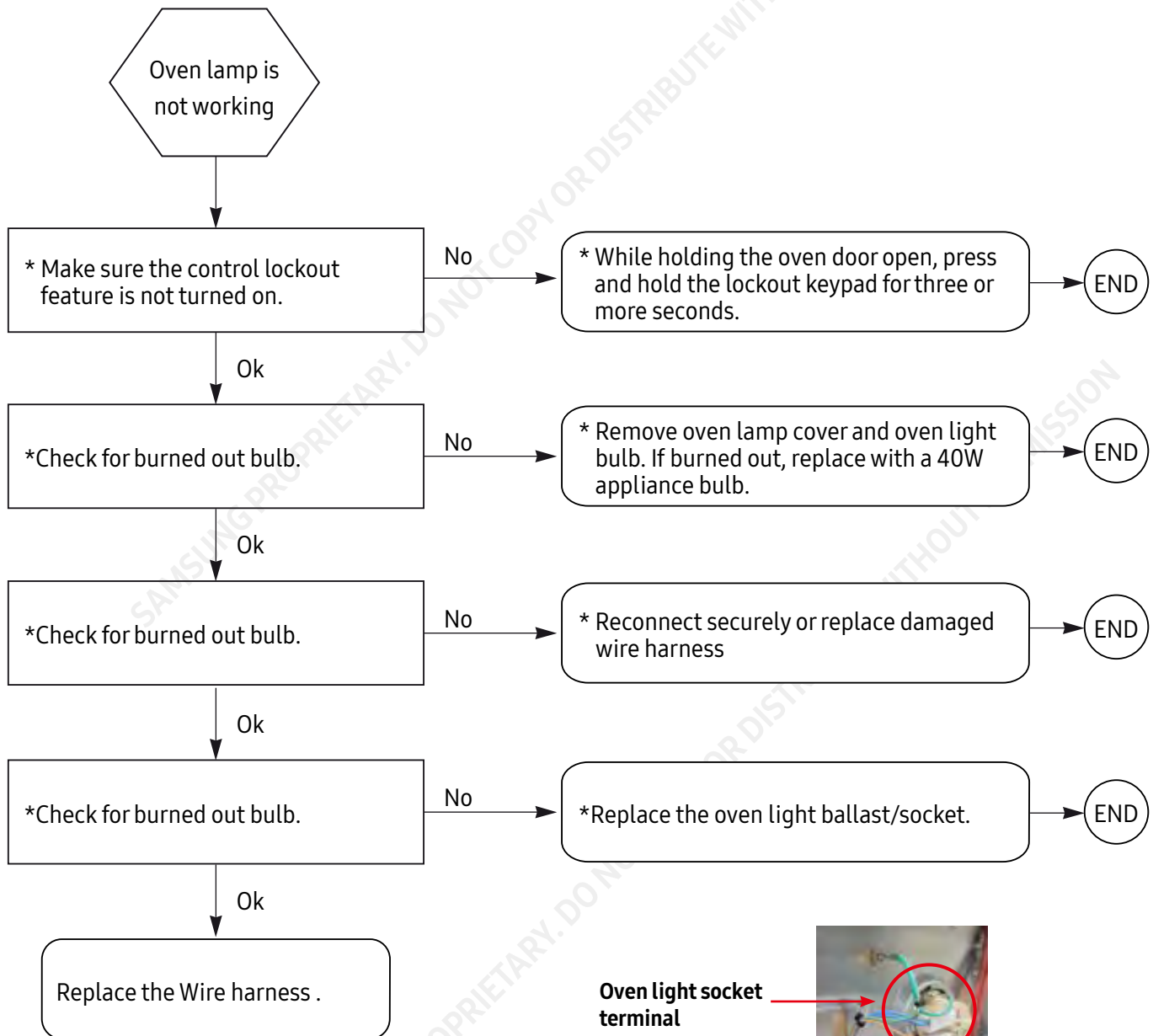

4. Troubleshooting

Oven parts

Convection fan not working

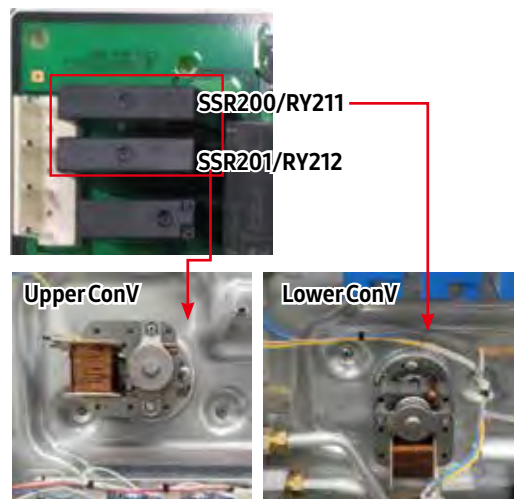
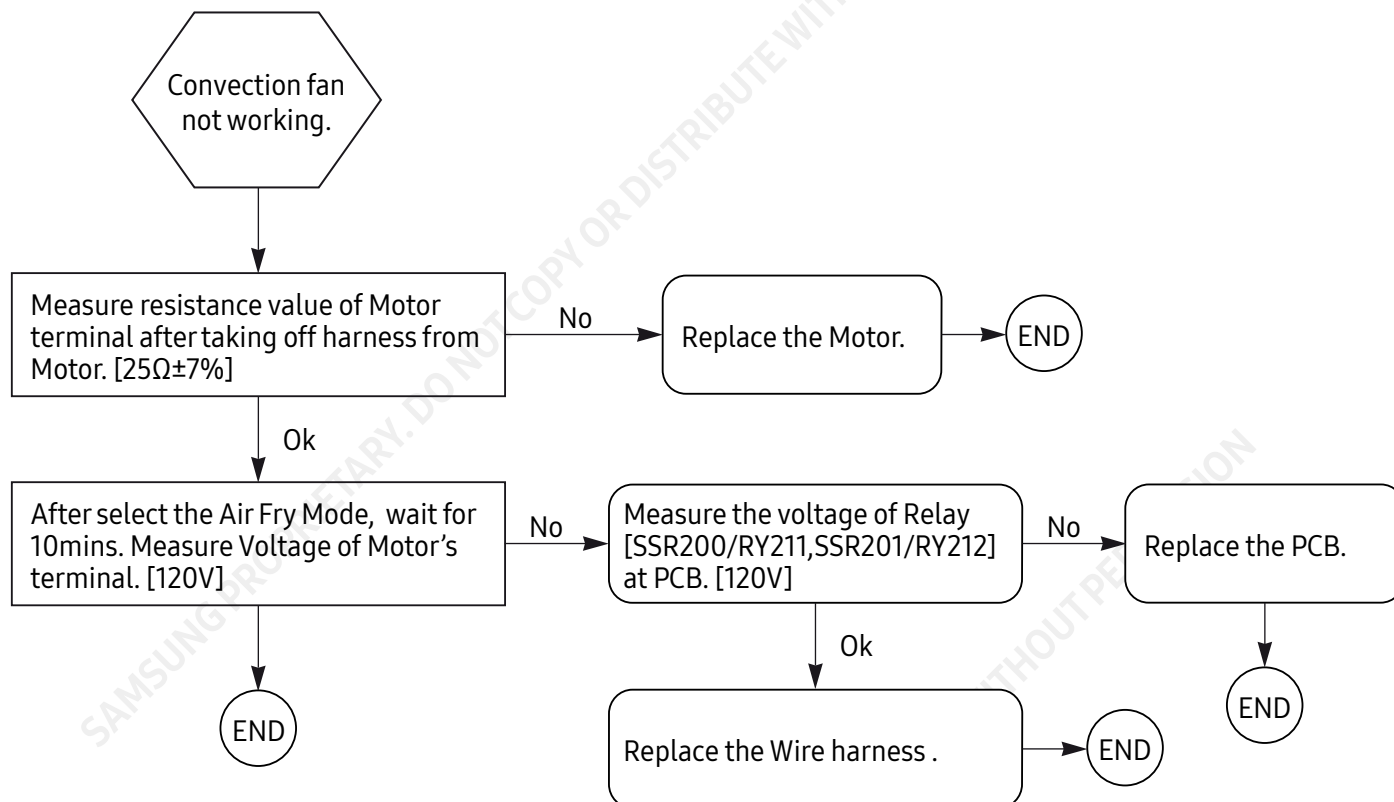

4. Troubleshooting

Oven parts

Wi-Fi Connection is not working

Step.1

- Check whether Wi-Fi function is set by "On". : Touch 'Smart Control' key 3 sec.
- If the Wi-Fi is not able to connect, register the range to SmartThings app by referring to the following instructions.
 - Make sure that the mobile phone is connected to 2.4GHz Wi-Fi network.
 - Do not use the hidden AP in the wireless router settings during the device registration.
 - Use a unique SSID consisting of the alphabetic letters and the numeric digits without any blank.
 - For Wi-Fi security protocols, WPA2-PSK_AES is recommended.



Step.2

- Check communication between Wi-Fi module and Sub PCB.
 - A) Press Cook time and Minus(<) at same time. (double key)
 - Display will show Project Name, Main Version, Panel Version, Display Version, Touch Version and Network PCB version.
 - If network version is ordinarily showed, try to use SMART CONTROL feature again.
 - If network version is abnormal, Check to Wi-Fi module. (2-B)
 - B) Check input voltage on Wi-Fi module. (12V)
 - If input Voltage have problem, Check to connector of Wire and Sub PCB. (CNS601)
 - If connection of wire have problem, re-connect and try SMART CONTROL feature again.
 - If input Voltage is ok, replace Sub PCB



Pin 24 : GND
Pin 25 : 12VDC

5. Wiring Diagram

5-1 Wiring Diagram

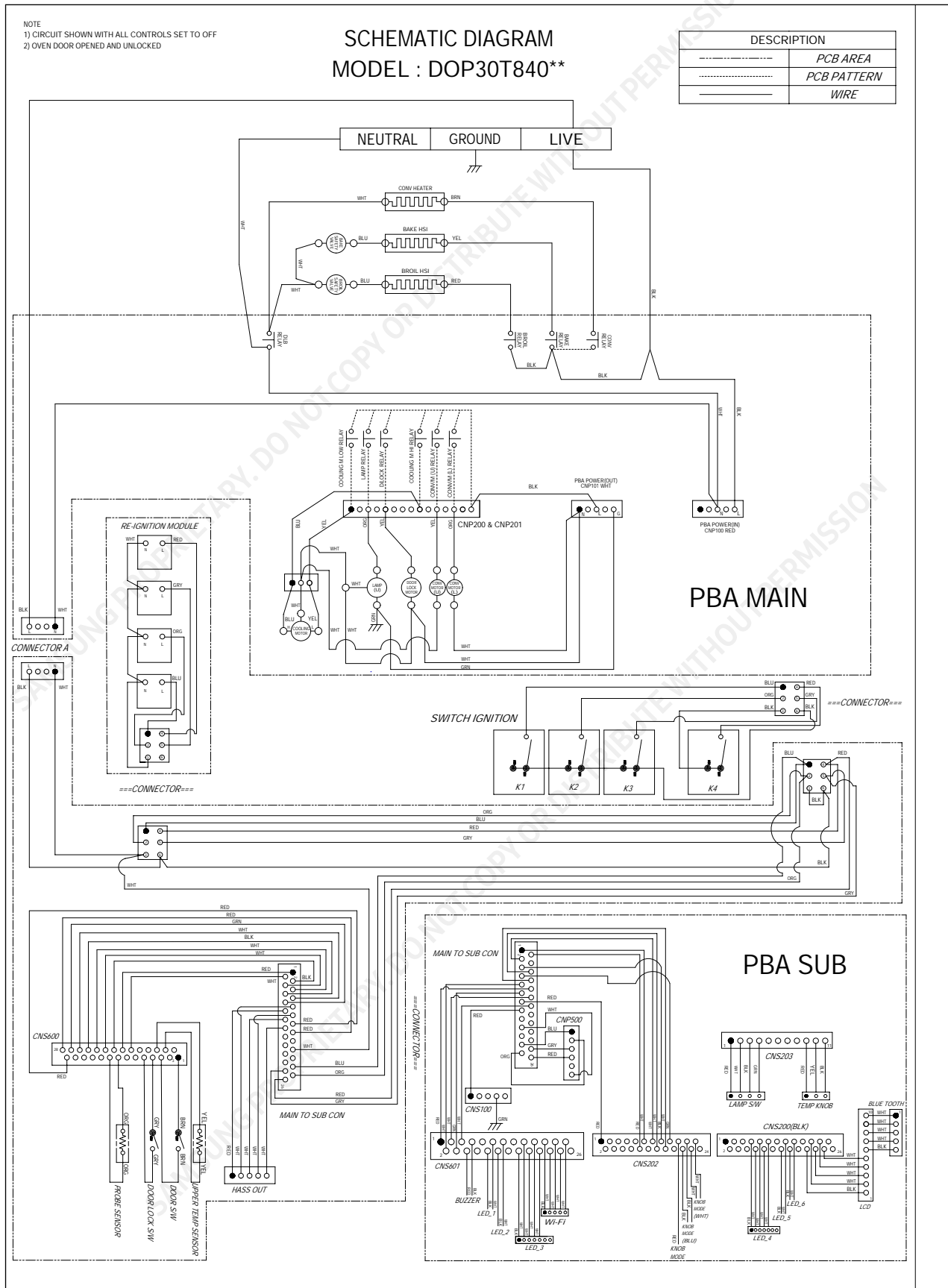

6. PCB Diagrams

6-1 Main PCB

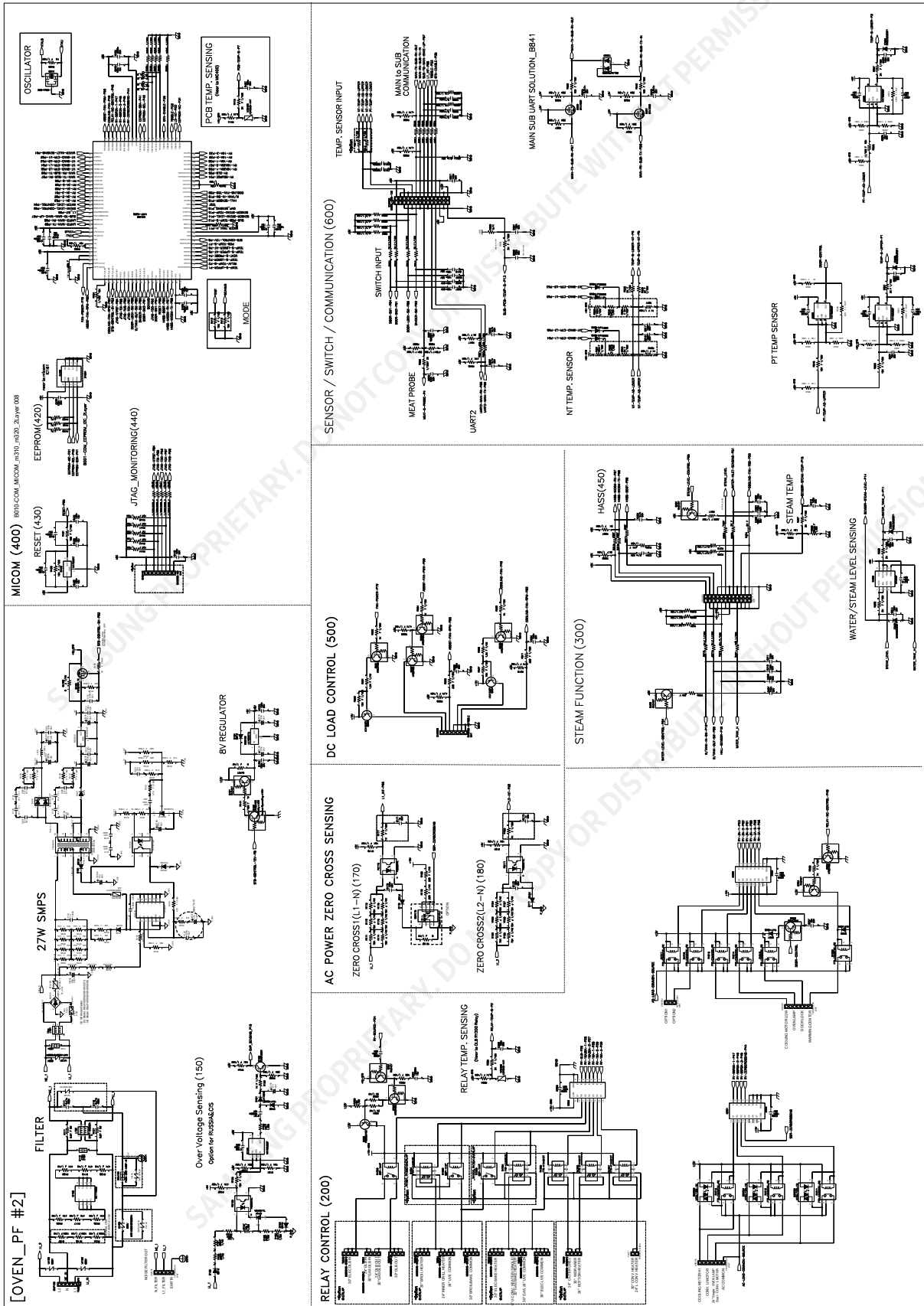

6. PCB Diagrams

6-2 Sub PCB

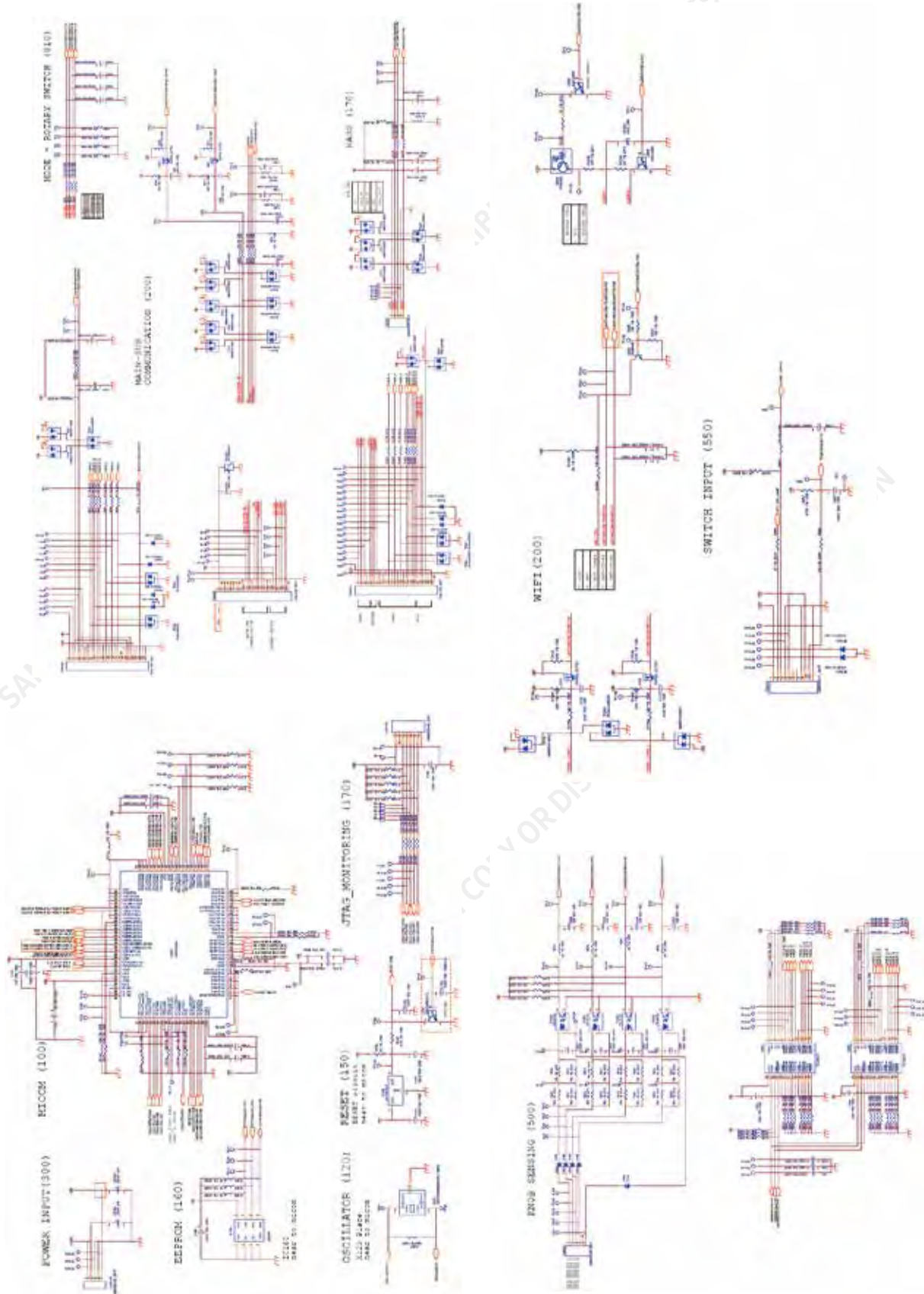

6. PCB Diagrams

6-3 Display PCB

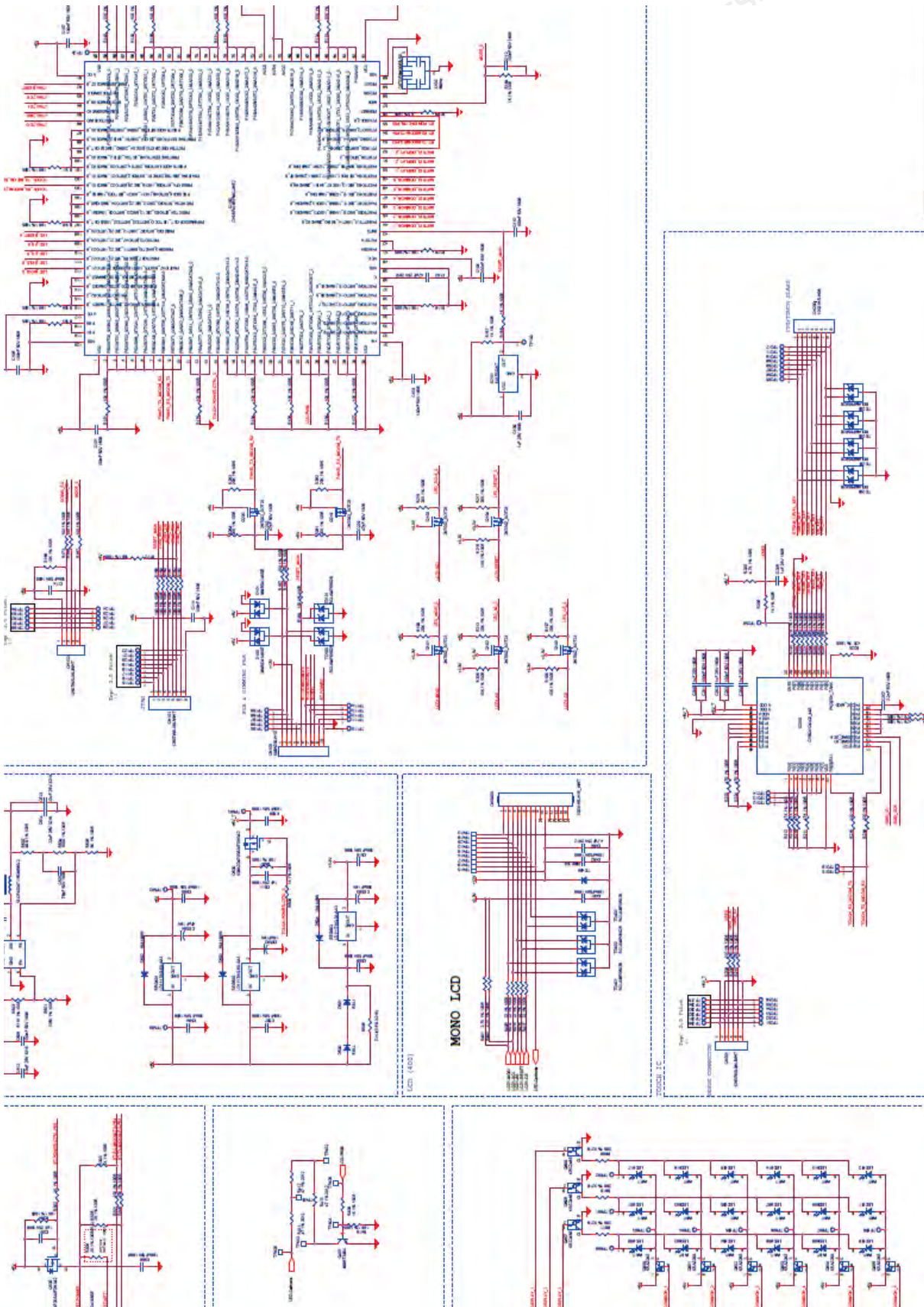

6. PCB Diagrams

6-4 PCB & Touch Keypad

Explanation of Touch Keypad



Touch Keypad

1. Touch control panel allows user to select time and temperature, set clock & option, Wi-Fi, probe on by touching the control panel in the front.
2. The marking on the front of touch glass acts as a guide for where the panel should be touched to select and program that function.
If touch control stops working, you can check connected state of touch film or replace the control panel.
3. Touch glass tail connects the Keypad to PCB.

6. PCB Diagrams

* Figure of PCB and Display

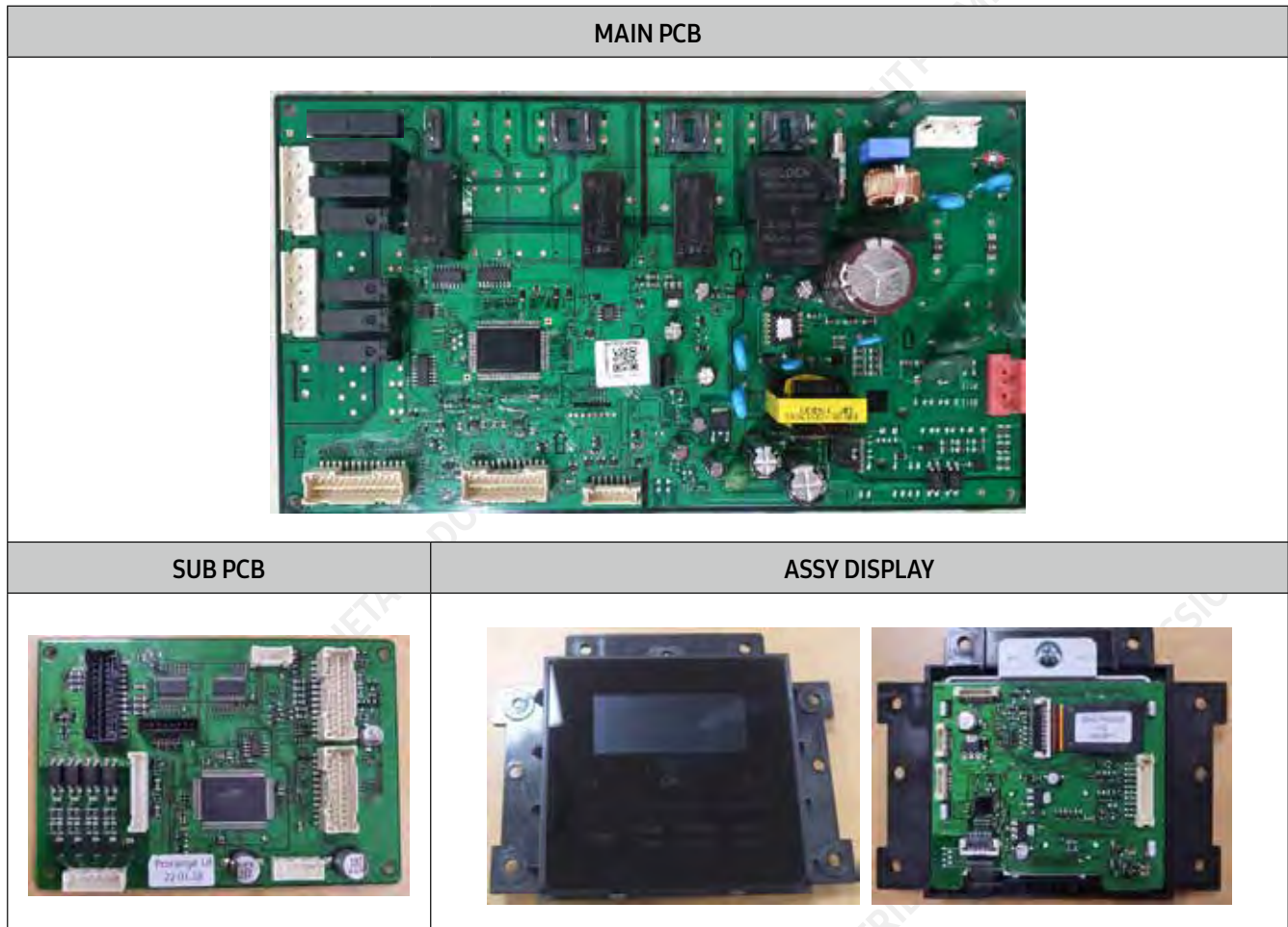

6. PCB Diagrams

6-5 PCB parts

Explanation of DOP30T840 Main PCB parts

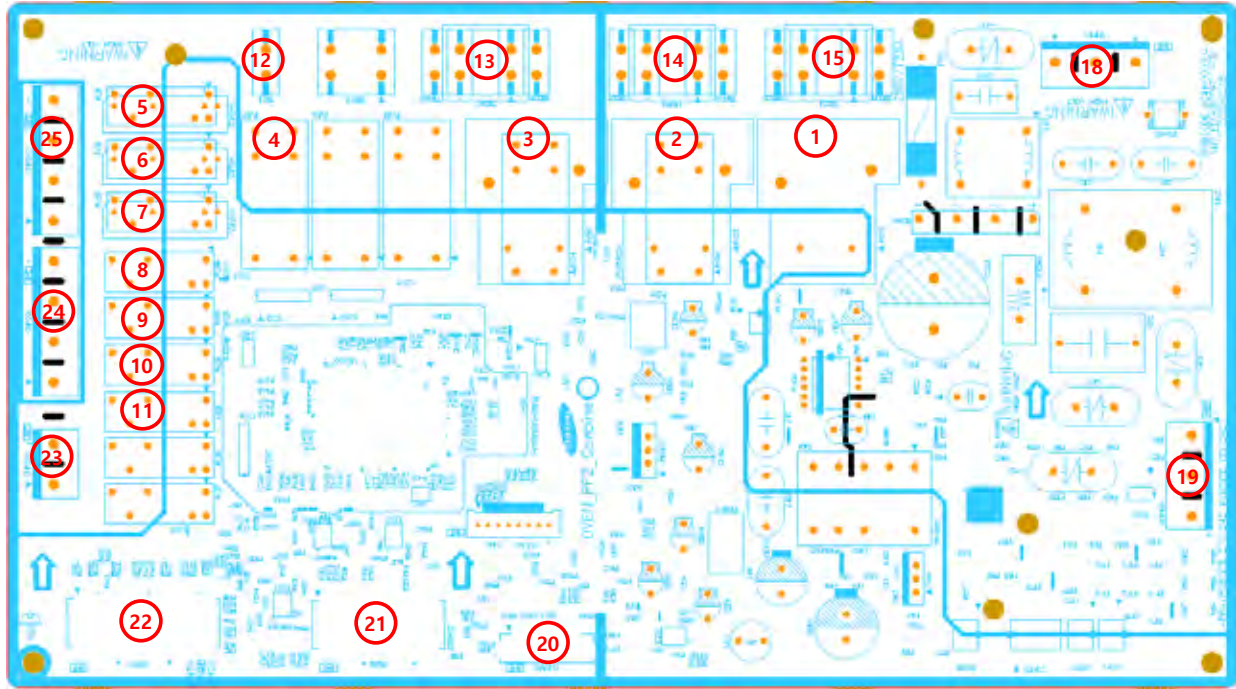

No.	Parts Number	Part Name	Function and Rule
1	RY200	DLB Relay	Circuit is designed to have broil relay or convection relay worked after DLB relay is being worked by Double line break. (It will not be problem with reversing the order in inserting Red)
2	RY201	Broil Relay	Broil relay(RY201), Bake relay(RY204), convection relay(RY207) will be on-off working by mi-com signal after DLB relay is worked. <ul style="list-style-type: none"> • Broil relay : It is relay for operating broil heater. It will not be problem with reversing the order in inserting Brown.) • Bake relay : It is relay for operating bake heater. It will not be problem with reversing the order in inserting Blue.) • Convection relay : It is relay for operating convection heater in Conv.Bake or Conv.Roast mode.
3	RY204	Bake Relay	
4	RY207	Convection Heater Relay	
5	SSR200	Convection Fan (Lower) Relay	This relay is connected with Lower convection fan motor.
6	SSR201	Convection Fan (Upper) Relay.	This relay is connected with Upper convection fan motor.
7	RY213	Cooling Fan Motor (Upper) Relay	This relay is connected with Upper cooling fan motor.
8	RY209	Warming Center Relay	Deleted (Not used)
9	RY210	Door Lock Relay	This relay is connected with Door lock motor .
10	RY214	Oven-Lamp Relay	This relay is connected with Oven lamp.
11	RY215	Cooling Fan Motor (Lower)	This relay is connected with Lpper cooling fan motor.
12	TB211	Conv. Heater Terminal	This terminal is for connecting harness with Convection heater relay.

6. PCB Diagrams

Explanation of DOP30T840 Main PCB parts

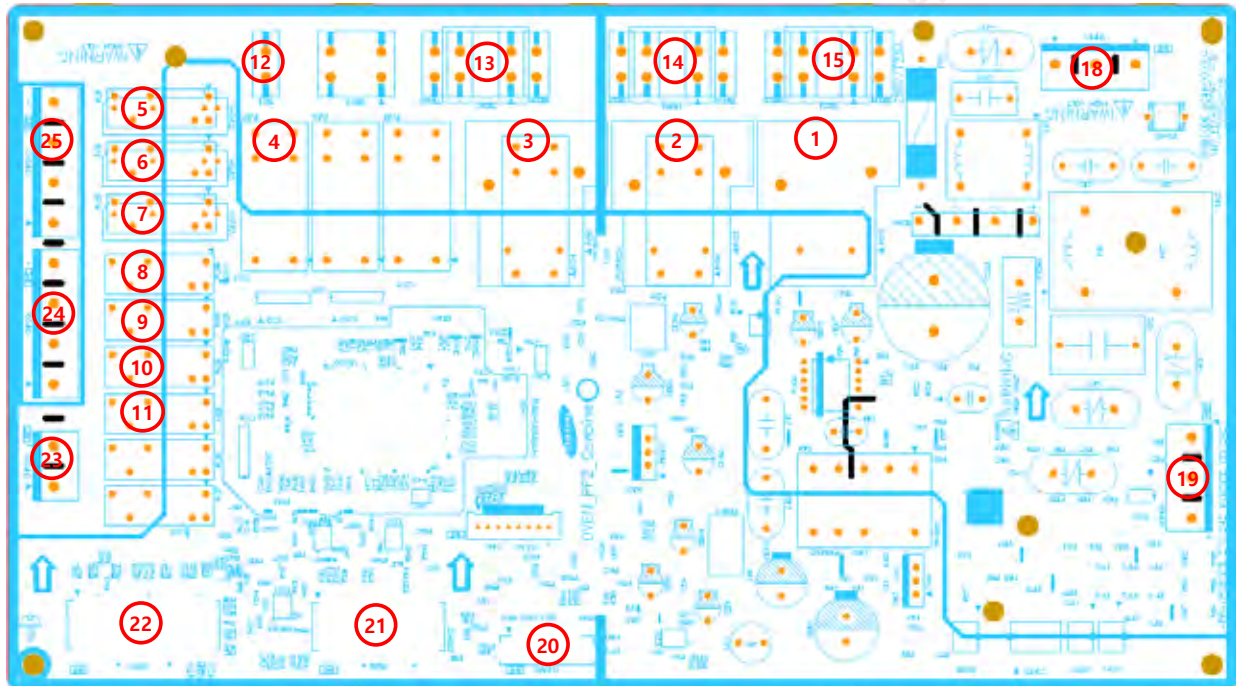

No.	Parts Number	Part Name	Function and Rule
13	TB207	Live Common Terminal Bake Heater Terminal	This terminal is for connecting with Bake heater(1,2) & AC Live Common(3,4).
14	TB204	Broil/Bake Common Terminal	This terminal is for connecting harness with Broil heater relay(1,2) & Broil/Bake relay(3,4).
15	TB201	DLB Terminal	This terminal is for connecting harness with DLB relay.
18	CNP101	Noise Filter Connector	This connector is for noise filter output.
19	CNP100	Power Connector	This connector is for supplying power to SMPS.
20	CNS500	DC Load Control Connector	Deleted (not used)
21	CNS300	HASS Connector	This connector is for HASS. (It is not to consumer.)
22	CNS600	Sensor/Switch/Communica- tion	This connector is for MAIN to SUB Communication & to control sensor, switch.
23	CNP202	Relay Control	Deleted (not used)
24	CNP201	Relay Control	This connector is connected to wire harness with Cooling Motor(Lower), Oven Lamp, Door Lock, Warming Center relay.
25	CNP200	Relay Control	This connector is connected to wire harness with Cooling Motor(Upper), Conv. Motor (Up- per), Conv. Motor (Lower) relay.

6. PCB Diagrams

Explanation of DOP30T840 Main PCB parts

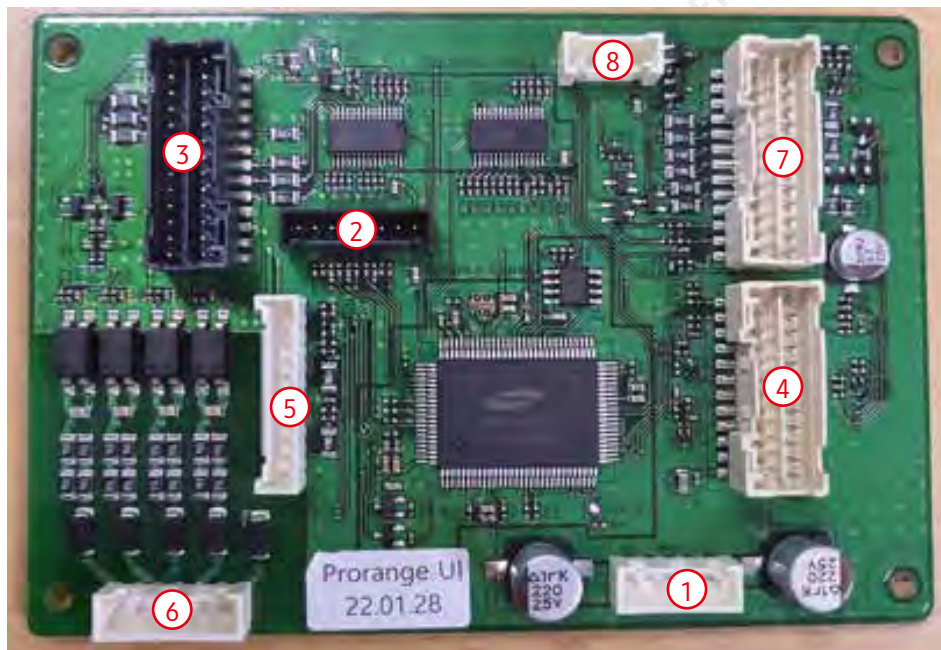

No.	Parts Number	Part Name	Function and Rule
1	CNS100	Main-Sub Power Input connector	This connector is for sub PBA power input
2	CNS180	JTAG Connector	Not using (only for developer)
3	CNS200	Sub-Display Communication connector	This connector is for communication between Sub and Display PBA, and knob lighting
4	CNS202	Main-Sub Communication connector	This connector is for communication between Main and Sub PBA, rotary switch sensing.
5	CNS203	Lamp/Temp Knob Switch connector	This connector is for lamp and temp knob switch input.
6	CNP500	Knob-sensing connector	This connector is for knob-sensing.
7	CNS601	Buzzer, Wifi connector	This connector is for buzzer, knob lighting, wifi connecting.
8	CNS602	MICOM Download Connector	This connector is for Micom S/W downloading

6. PCB Diagrams

Explanation of DOP30T840 Display PCB parts

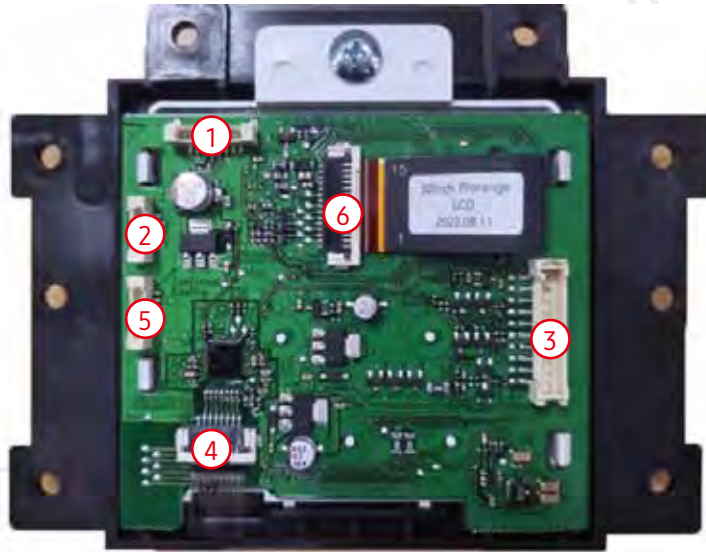

No.	Parts Number	Part Name	Function and Rule
1	CN101	JTAG Connector	Not using (only for developer)
2	CN102	MICOM Download Connector	This connector is for Micom S/W downloading
3	CN103	Sub-Display Comm/Bluetooth Connector	This connector is for Sub/Display communication and bluetooth.
4	CN200	Touch Film Connector	This connector is for Touch-Film.
5	CN201	Touch Download Connector	This connector is for downloading program for touch IC. (only for developer)
6	CNS400	LCD Connector	This connector is for LCD.

SAMSUNG

GSPN (GLOBAL SERVICE PARTNER NETWORK)

Area	Web Site
Europe, CIS, Mideast & Africa	gspn1.samsungcportal.com
Asia	gspn2.samsungcportal.com
North & Latin America	gspn3.samsungcportal.com
China	china.samsungportal.com

This service manual is the property of Samsung Electronics Co., Ltd.
Any unauthorized use of this manual can be punished under applicable
international and/or domestic law.

© Samsung Electronics Co., Ltd. May. 2023
Printed in Korea